











RONIS key-operated switch, 30 mm, round, metal, matte, front ring for flush installation, lock number SB30, with 2 keys, 3 switch positions I-O-II, latching, actuating angle 2x45°, 10:30h/12h/13:30h, Key removal I+O+II, possible special locks: SB31, 421, 455

product brand name	SIRIUS ACT
product designation	Key-operated switches
design of the product	Actuating/signaling element
product type designation	3SU1
product line	Metal, matt, flat, 30 mm
manufacturer's article number of included key	3SU1950-0FB80-0AA0
Actuator	
principle of operation of the actuating element	latching, 2x45° (10:30 h/12 h/13:30 h)
product extension optional light source	No
color	
• of the actuating element	silver
material of the actuating element	metal
shape of the actuating element	Key
outer diameter of the actuating element	38 mm
number of switching positions	3
switch position for key distraction	O+I+II
actuating angle	
• clockwise	45°
• anticlockwise	45°
lock make	RONIS
key number	SB30
Front ring	
product component front ring	Yes
design of the front ring	Standard
material of the front ring	Metal, matt
color of the front ring	sand gray
General technical data	
protection class IP	IP66, IP67, IP69(IP69K)
protection class IP of the terminal	IP20
degree of protection NEMA rating	1, 2, 3, 3R, 4, 4X, 12, 13
shock resistance	
• according to IEC 60068-2-27	sinusoidal half-wave 15g / 11 ms
• for railway applications according to EN 61373	Category 1, Class B
vibration resistance	
• according to IEC 60068-2-6	10 ... 500 Hz: 5g
• for railway applications according to EN 61373	Category 1, Class B
operating frequency maximum	1 800 1/h
mechanical service life (operating cycles) typical	300 000
reference code according to IEC 81346-2	S

Substance Prohibittance (Date)	10/01/2014
Weight	97 g
Ambient conditions	
ambient temperature	
• during operation	-25 ... +70 °C
• during storage	-40 ... +80 °C
environmental category during operation according to IEC 60721	3M6, 3S2, 3B2, 3C3, 3K6 (with relative air humidity of 10 ... 95%)
Installation/ mounting/ dimensions	
height	44.8 mm
width	38 mm
shape of the installation opening	round
mounting diameter	30.5 mm
positive tolerance of installation diameter	0.5 mm
mounting height	42.7 mm
installation width	38 mm
installation depth	32.1 mm
Approvals Certificates	
General Product Approval	Test Certificates
 EG-Konf.   	Special Test Certificate Type Test Certificates/Test Report
Maritime application	other
  LRS   	Confirmation
Environment	
Environmental Conformations	
Further information	
Information on the packaging https://support.industry.siemens.com/cs/ww/en/view/109813875 Information for data generation and storage https://support.industry.siemens.com/cs/ww/en/view/109995012 Information- and Downloadcenter (Catalogs, Brochures,...) https://www.siemens.com/ic10 Industry Mall (Online ordering system) https://mall.industry.siemens.com/mall/en/en/Catalog/product?mlfb=3SU1060-4LL11-0AA0 Cax online generator https://support.automation.siemens.com/WW/CAXorder/default.aspx?lang=en&mlfb=3SU1060-4LL11-0AA0 Service&Support (Manuals, Certificates, Characteristics, FAQs,...) https://support.industry.siemens.com/cs/ww/en/ps/3SU1060-4LL11-0AA0 Image database (product images, 2D dimension drawings, 3D models, device circuit diagrams, EPLAN macros, ...) https://www.automation.siemens.com/bilddb/cax_de.aspx?mlfb=3SU1060-4LL11-0AA0&lang=en	

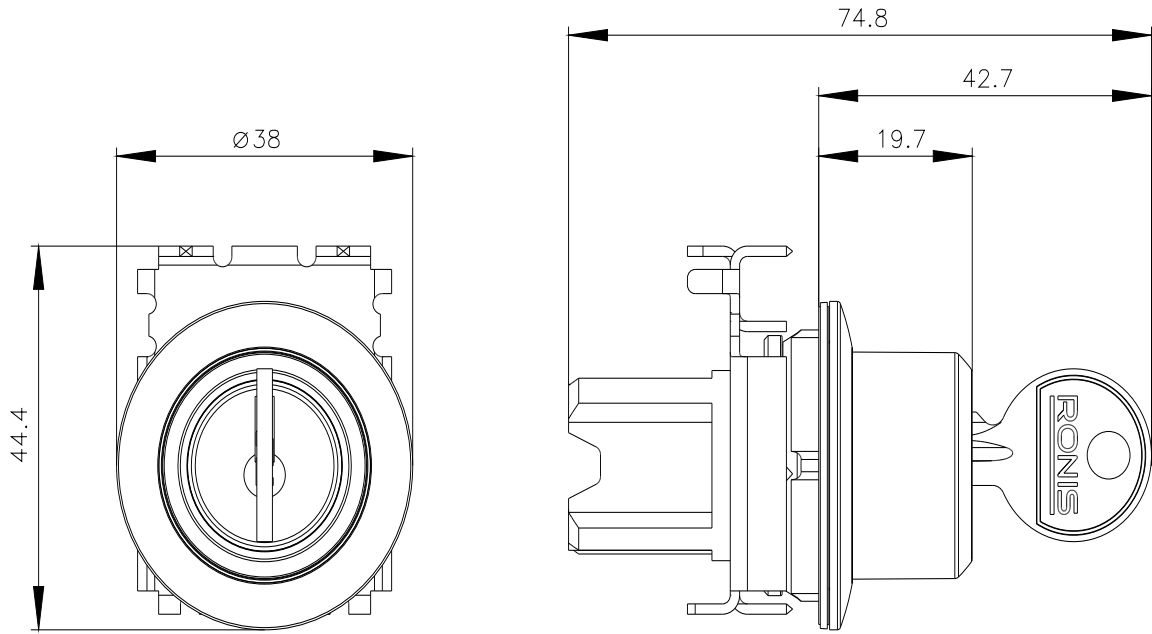

last modified:

7/6/2025 