

Siemens  
EcoTech



Selector switch, illuminable, 22 mm, round, metal, shiny, white, selector switch, short, 3 switch positions I-O<II, left latching, right momentary contact type, actuating angle 2x45°, 10:30h/12h/13:30h



product brand name	SIRIUS ACT
product designation	Selector switches
design of the product	Actuating/signaling element
product type designation	3SU1
product line	Metal, shiny, 22 mm
<b>Enclosure</b>	
number of command points	1
<b>Actuator</b>	
design of the actuating element	Selector, short
principle of operation of the actuating element	latching/momentary contact, 2x45° (10:30 h/12 h/13:30 h), return from right, left latching
product extension optional	
• light source	Yes
• contact module	Yes
color of the actuating element	white
material of the actuating element	plastic
shape of the actuating element	Handle
outer diameter of the actuating element	32.3 mm
number of switching positions	3
actuating angle	
• clockwise	45°
• anticlockwise	45°
<b>Front ring</b>	
product component front ring	Yes
design of the front ring	standard
material of the front ring	Metal, high gloss
color of the front ring	silver
<b>General technical data</b>	
protection class IP	IP66, IP67, IP69(IP69K)
degree of protection NEMA rating	1, 2, 3, 3R, 4, 4X, 12, 13
shock resistance	
• according to IEC 60068-2-27	sinusoidal half-wave 15g / 11 ms
vibration resistance	
• according to IEC 60068-2-6	10 ... 500 Hz: 5g
operating frequency maximum	1 800 1/h
mechanical service life (operating cycles) typical	1 000 000

reference code according to IEC 81346-2	S
Substance Prohibance (Date)	10/01/2014
Weight	50 g

**Safety related data**

<b>proportion of dangerous failures</b>	
<ul style="list-style-type: none"> <li>with low demand rate according to SN 31920</li> </ul>	20 %
<ul style="list-style-type: none"> <li>with high demand rate per NC contact according to SN 31920</li> </ul>	20 %
<ul style="list-style-type: none"> <li>with high demand rate per NO contact according to SN 31920</li> </ul>	50 %
<b>B10 value with high demand rate according to SN 31920</b>	300 000
<b>failure rate [FIT] with low demand rate per NC contact according to SN 31920</b>	100 FIT

IEC 61508	
T1 value for proof test interval or service life according to IEC 61508	20 a

**Ambient conditions**

<b>ambient temperature</b>	
<ul style="list-style-type: none"> <li>during operation</li> </ul>	-25 ... +70 °C
<ul style="list-style-type: none"> <li>during storage</li> </ul>	-40 ... +80 °C
environmental category during operation according to IEC 60721	3M6, 3S2, 3B2, 3C3, 3K6 (with relative air humidity of 10 ... 95%)





**Environmental footprint**

Environmental Product Declaration (EPD)	Yes
global warming potential [CO2 eq] total	0.593 kg
global warming potential [CO2 eq] during manufacturing	0.625 kg
global warming potential [CO2 eq] during operation	0.235 kg
global warming potential [CO2 eq] after end of life	-0.267 kg
Siemens Eco Profile (SEP)	Siemens EcoTech

**Installation/ mounting/ dimensions**

height	32.3 mm
width	32.3 mm
shape of the installation opening	round
mounting diameter	22.3 mm
positive tolerance of installation diameter	0.4 mm
mounting height	28.8 mm
installation width	32.3 mm
installation depth	25.4 mm



**Approvals Certificates**

General Product Approval	Test Certificates
   	<a href="#">Special Test Certificate</a> <a href="#">Type Test Certificates/Test Report</a>

**Maritime application**

    	<a href="#">Confirmation</a>
---	------------------------------

**Environment**

 	<a href="#">Environmental Confirmations</a>
---	---

## Further information

### Information on the packaging

<https://support.industry.siemens.com/cs/ww/en/view/109813875>

### Information for data generation and storage

<https://support.industry.siemens.com/cs/ww/en/view/109995012>

### Information- and Downloadcenter (Catalogs, Brochures,...)

<https://www.siemens.com/ic10>

### Industry Mall (Online ordering system)

<https://mall.industry.siemens.com/mall/en/en/Catalog/product?mlfb=3SU1052-2BN60-0AA0>

### Cax online generator

<https://support.automation.siemens.com/WW/CAXorder/default.aspx?lang=en&mlfb=3SU1052-2BN60-0AA0>

### Service&Support (Manuals, Certificates, Characteristics, FAQs,...)

<https://support.industry.siemens.com/cs/ww/en/ps/3SU1052-2BN60-0AA0>

### Image database (product images, 2D dimension drawings, 3D models, device circuit diagrams, EPLAN macros, ...)

[https://www.automation.siemens.com/bilddb/cax\\_de.aspx?mlfb=3SU1052-2BN60-0AA0&lang=en](https://www.automation.siemens.com/bilddb/cax_de.aspx?mlfb=3SU1052-2BN60-0AA0&lang=en)

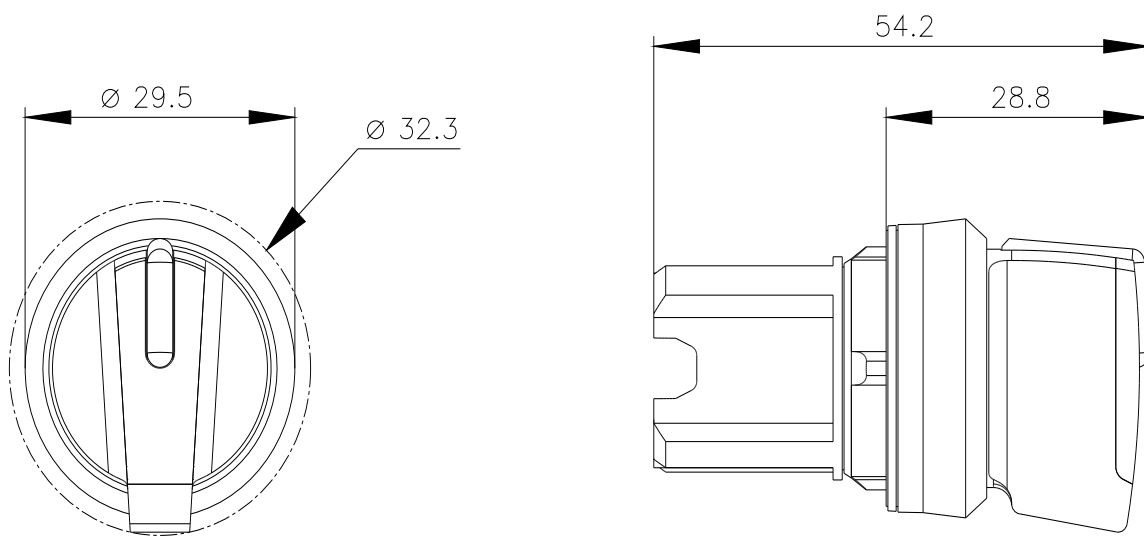

last modified:

5/21/2025 