











Siemens
EcoTech



Coordinate switch, 22 mm, round, metal shiny, black, 2 switch positions, horizontal momentary contact type, without mechanical interlocking



product brand name	SIRIUS ACT
product designation	Coordinate switches
design of the product	Actuating/signaling element
product type designation	3SU1
product line	Metal, shiny, 22 mm
Enclosure	
number of command points	1
Actuator	
design of the actuating element	without mechanical interlock
principle of operation of the actuating element	momentary contact type
direction of actuation	horizontal
product extension optional	
• light source	No
• contact module	Yes
color of the actuating element	black
material of the actuating element	plastic
shape of the actuating element	Extended handle
outer diameter of the actuating element	30.5 mm
number of switching positions	2
Maximum deflection angle [°]	30°
Front ring	
product component front ring	Yes
design of the front ring	high
material of the front ring	Metal, high gloss
color of the front ring	silver
General technical data	
protection class IP	IP65, IP67
degree of protection NEMA rating	1, 2, 3, 3R, 4, 4X, 12, 13
shock resistance	
• according to IEC 60068-2-27	sinusoidal half-wave 15g / 11 ms
vibration resistance	
• according to IEC 60068-2-6	10 ... 500 Hz: 5g
operating frequency maximum	2 400 1/h
mechanical service life (operating cycles)	
• as operating period per direction of actuation typical	500 000
reference code according to IEC 81346-2	S

Substance Prohibittance (Date)	10/01/2014
SVHC substance name	Melamine - 108-78-1
Weight	85 g
Safety related data	
proportion of dangerous failures	
• with low demand rate according to SN 31920	20 %
• with high demand rate according to SN 31920	20 %
B10 value with high demand rate according to SN 31920	250 000
failure rate [FIT] with low demand rate according to SN 31920	100 FIT
IEC 61508	
T1 value for proof test interval or service life according to IEC 61508	20 a
Ambient conditions	
ambient temperature	
• during operation	-25 ... +70 °C
• during storage	-40 ... +80 °C
environmental category during operation according to IEC 60721	3M6, 3S2, 3B2, 3C3, 3K6 (with relative air humidity of 10 ... 95%)
Environmental footprint	
Environmental Product Declaration (EPD)	Yes
global warming potential [CO2 eq] total	0.593 kg
global warming potential [CO2 eq] during manufacturing	0.625 kg
global warming potential [CO2 eq] during operation	0.235 kg
global warming potential [CO2 eq] after end of life	-0.267 kg
Siemens Eco Profile (SEP)	Siemens EcoTech
Installation/ mounting/ dimensions	
height	30.5 mm
width	30.5 mm
shape of the installation opening	round
mounting diameter	22.3 mm
positive tolerance of installation diameter	0.4 mm
mounting height	71.3 mm
installation width	30.5 mm
installation depth	25.6 mm
Approvals Certificates	
General Product Approval	Test Certificates
   	Special Test Certificate Type Test Certificates/Test Report
Maritime application	other
   	 Confirmation
Environment	
 	Environmental Confirmations
Further information	
Information on the packaging https://support.industry.siemens.com/cs/ww/en/view/109813875	

Information for data generation and storage

<https://support.industry.siemens.com/cs/ww/en/view/109995012>

Information- and Downloadcenter (Catalogs, Brochures,...)

<https://www.siemens.com/ic10>

Industry Mall (Online ordering system)

<https://mall.industry.siemens.com/mall/en/en/Catalog/product?mlfb=3SU1050-7AC88-0AA0>

Cax online generator

<https://support.automation.siemens.com/WW/CAXorder/default.aspx?lang=en&mlfb=3SU1050-7AC88-0AA0>

Service&Support (Manuals, Certificates, Characteristics, FAQs,...)

<https://support.industry.siemens.com/cs/ww/en/ps/3SU1050-7AC88-0AA0>

Image database (product images, 2D dimension drawings, 3D models, device circuit diagrams, EPLAN macros, ...)

https://www.automation.siemens.com/bilddb/cax_de.aspx?mlfb=3SU1050-7AC88-0AA0&lang=en

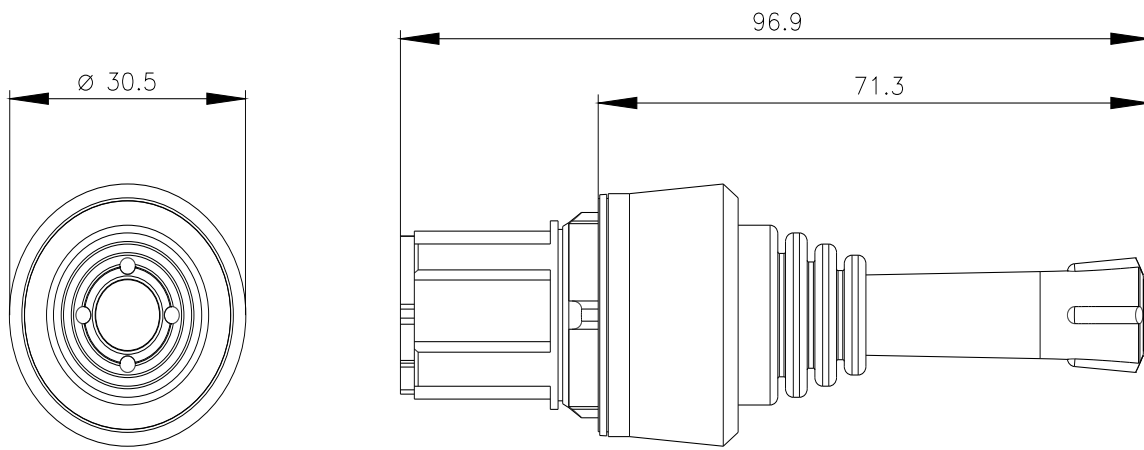

last modified:

9/18/2025 