











Siemens
EcoTech



Coordinate switch, 22 mm, round, plastic, black, 2 switch positions, horizontal latching, with mechanical interlocking



| | |
|----------------------------------------------------------|----------------------------------|
| product brand name | SIRIUS ACT |
| product designation | Coordinate switches |
| design of the product | Actuating/signaling element |
| product type designation | 3SU1 |
| product line | Plastic, black, 22 mm |
| Enclosure | |
| number of command points | 1 |
| Actuator | |
| design of the actuating element | with mechanical interlocking |
| principle of operation of the actuating element | latching |
| direction of actuation | horizontal |
| product extension optional | |
| • light source | No |
| • contact module | Yes |
| color of the actuating element | black |
| material of the actuating element | plastic |
| shape of the actuating element | Extended handle |
| outer diameter of the actuating element | 30.5 mm |
| type of unlocking device | push-to-unlatch mechanism |
| number of switching positions | 2 |
| Maximum deflection angle [°] | 30° |
| Front ring | |
| product component front ring | Yes |
| design of the front ring | high |
| material of the front ring | plastic |
| color of the front ring | black |
| General technical data | |
| protection class IP | IP65, IP67 |
| degree of protection NEMA rating | 1, 2, 3, 3R, 4, 4X, 12, 13 |
| shock resistance | |
| • according to IEC 60068-2-27 | sinusoidal half-wave 15g / 11 ms |
| vibration resistance | |
| • according to IEC 60068-2-6 | 10 ... 500 Hz: 5g |
| operating frequency maximum | 2 400 1/h |
| mechanical service life (operating cycles) | |
| • as operating period per direction of actuation typical | 100 000 |

| | |
|-------------------------------------------------------------------------------------------------------------------------------------------------------------------------------------------------------------------------------------------------------------------------------------------------------------------------------------------------|--------------------------------------------------------------------------------------------------------------------|
| reference code according to IEC 81346-2 | S |
| Substance Prohibittance (Date) | 10/01/2014 |
| Weight | 43 g |
| Safety related data | |
| proportion of dangerous failures | |
| • with low demand rate according to SN 31920 | 20 % |
| • with high demand rate according to SN 31920 | 20 % |
| B10 value with high demand rate according to SN 31920 | 100 000 |
| failure rate [FIT] with low demand rate according to SN 31920 | 100 FIT |
| IEC 61508 | |
| T1 value for proof test interval or service life according to IEC 61508 | 20 a |
| Ambient conditions | |
| ambient temperature | |
| • during operation | -25 ... +70 °C |
| • during storage | -40 ... +80 °C |
| environmental category during operation according to IEC 60721 | 3M6, 3S2, 3B2, 3C3, 3K6 (with relative air humidity of 10 ... 95%) |
| Environmental footprint | |
| Environmental Product Declaration (EPD) | Yes |
| global warming potential [CO2 eq] total | 0.787 kg |
| global warming potential [CO2 eq] during manufacturing | 0.566 kg |
| global warming potential [CO2 eq] during operation | 0.235 kg |
| global warming potential [CO2 eq] after end of life | -0.015 kg |
| Siemens Eco Profile (SEP) | Siemens EcoTech |
| Installation/ mounting/ dimensions | |
| height | 30.5 mm |
| width | 30.5 mm |
| shape of the installation opening | round |
| mounting diameter | 22.3 mm |
| positive tolerance of installation diameter | 0.4 mm |
| mounting height | 75.6 mm |
| installation width | 30.5 mm |
| installation depth | 25.5 mm |
| Approvals Certificates | |
| General Product Approval | Test Certificates |
|     | Special Test Certificate Type Test Certificates/Test Report |
| Maritime application | other |
|     |  Confirmation |
| Environment | |
|   | Environmental Confirmations |
| Further information | |
| Information on the packaging https://support.industry.siemens.com/cs/ww/en/view/109813875 | |

Information for data generation and storage

<https://support.industry.siemens.com/cs/ww/en/view/109995012>

Information- and Downloadcenter (Catalogs, Brochures,...)

<https://www.siemens.com/ic10>

Industry Mall (Online ordering system)

<https://mall.industry.siemens.com/mall/en/en/Catalog/product?mlfb=3SU1000-7BA10-0AA0>

Cax online generator

<https://support.automation.siemens.com/WW/CAXorder/default.aspx?lang=en&mlfb=3SU1000-7BA10-0AA0>

Service&Support (Manuals, Certificates, Characteristics, FAQs,...)

<https://support.industry.siemens.com/cs/ww/en/ps/3SU1000-7BA10-0AA0>

Image database (product images, 2D dimension drawings, 3D models, device circuit diagrams, EPLAN macros, ...)

https://www.automation.siemens.com/bilddb/cax_de.aspx?mlfb=3SU1000-7BA10-0AA0&lang=en

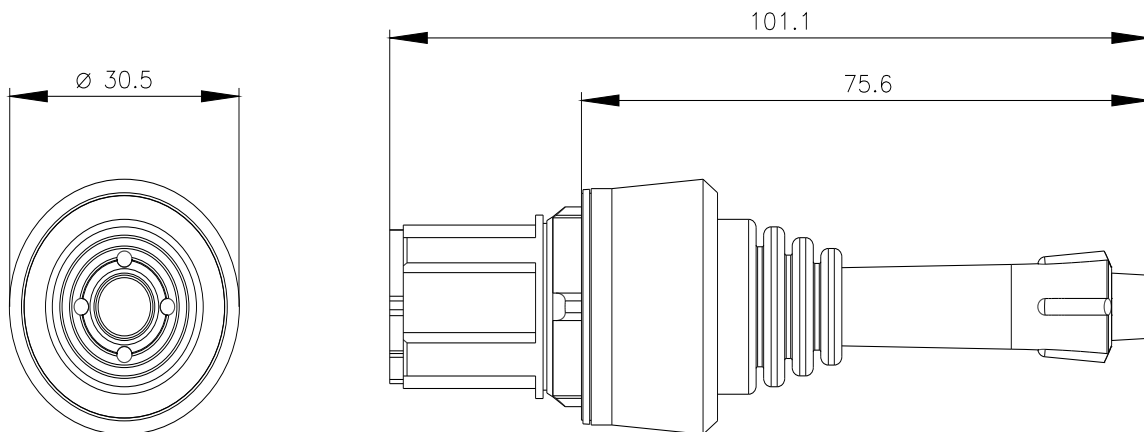

last modified:

4/2/2025 