







Safety position switch with tumbler Locking force 2600 N 5 directions of approaches Spring-locked Escape release from the rear and auxiliary release on front Magnet voltage 230 V AC Monitoring actuator 2 NC/1 NO Monitoring magnet 2 NC/1 NO LED display yellow/green Supplied without actuator. Actuator 3SE5000-0AV0. please order separately

product brand name	SIRIUS
product designation	Mechanical safety switches
design of the product	with separate actuator and with tumbler
product type designation	3SE5
manufacturer's article number of the optional actuators	3SE5000-0AV01 standard actuator, 3SE5000-0AV02 actuator with vertical fixing, 3SE5000-0AV03 actuator with transverse fixing, 3SE5000-0AV04 radius actuator, approach from left, 3SE5000-0AV05 universal actuator, 3SE5000-0AV06 radius actuator, approach from right, 3SE5000-0AV07 Heavy Duty actuator, 3SE5000-0AW42 actuator with vertical fixing, stainless steel socket, 3SE5000-0AW43 actuator with transverse fixing, stainless steel socket, 3SE5000-0AW51 stainless steel actuator, 3SE5000-0AW52 stainless steel actuator with vertical fixing, 3SE5000-0AW53 stainless steel actuator with transverse fixing
suitability for use safety switch	Yes
<b>General technical data</b>	
product function positive opening	Yes
locking force	2 600 N
• according to EN ISO 14119	2 000 N
insulation voltage rated value	250 V
degree of pollution	class 3
surge voltage resistance rated value	4 kV
protection class IP	IP65/IP67
shock resistance	30g / 11 ms
• according to IEC 60068-2-27	30g / 11 ms
vibration resistance	0.35 mm / 5g
• according to IEC 60068-2-6	0.35 mm/5g
mechanical service life (operating cycles) typical	1 000 000
thermal current	10 A
material of the enclosure of the switch head	metal
reference code according to IEC 81346-2	B
continuous current of the C characteristic MCB	1 A; for a short-circuit current smaller than 400 A
continuous current of the quick DIAZED fuse link	10 A; for a short-circuit current smaller than 400 A
continuous current of the DIAZED fuse link gG	6 A; for a short-circuit current smaller than 400 A
repeat accuracy	0.05 mm
Substance Prohibition (Date)	10/01/2011
SVHC substance name	Lead - 7439-92-1 Lead monoxide (lead oxide) - 1317-36-8 Imidazolidine-2-thione (2-imidazoline-2-thiol) - 96-45-7
Weight	1.264 kg
minimum actuating force in directions of actuation	30 N
length of the sensor	185 mm
width of the sensor	54 mm
<b>Ambient conditions</b>	

<b>ambient temperature</b>					
• during operation	-25 ... +60 °C				
• during storage	-40 ... +80 °C				
<b>explosion protection category for dust</b>	none				
<b>consumed active power of magnet coil</b>	4 W				
<b>operational current at AC-15</b>					
• at 24 V rated value	6 A				
• at 120 V rated value	6 A				
• at 240 V rated value	3 A				
<b>operational current at DC-13</b>					
• at 24 V rated value	3 A				
• at 125 V rated value	0.55 A				
• at 250 V rated value	0.27 A				
<b>Enclosure</b>					
<b>design of the housing</b>	special design				
<b>material of the enclosure</b>	metal				
<b>coating of the enclosure</b>	cathodic dip coating				
<b>design of the housing according to standard</b>	No				
<b>locking mechanism design</b>	spring-actuated lock (closed-circuit principle) with escape release from the back and auxiliary release from the front				
<b>Drive Head</b>					
<b>design of the actuating element</b>	5 directions of approach				
<b>design of the switching function</b>	positive opening				
<b>number of directions of actuation</b>	5				
<b>circuit principle</b>	slow-action contacts				
number of switching contacts safety-related	4				
<b>cable entry type</b>	3x (M20 x 1.5)				
<b>Installation/ mounting/ dimensions</b>					
<b>mounting position</b>	any				
<b>fastening method</b>	screw fixing				
<b>Connections/ Terminals</b>					
<b>type of electrical connection</b>	screw terminal				
<b>type of connectable conductor cross-sections</b>					
• solid	1x (0.5 ... 1.5 mm <sup>2</sup> ), 2x (0.5 ... 0.75 mm <sup>2</sup> )				
• finely stranded with core end processing	1x (0.5 ... 1.5 mm <sup>2</sup> ), 2x (0.5 ... 0.75 mm <sup>2</sup> )				
• for AWG cables solid	1x (20 ... 16), 2x (20 ... 18)				
• for AWG cables stranded	1x (20 ... 16), 2x (20 ... 18)				
<b>Supply voltage</b>					
type of voltage of the supply voltage of the optional LED display	AC				
<b>supply voltage of LED</b>					
•	230 V				
<b>supply voltage of magnet coil</b>	230 V				
design of the interface for safety-related communication	without				
<b>Communication/ Protocol</b>					
<b>design of the interface</b>	without				
<b>Safety related data</b>					
proportion of dangerous failures with high demand rate according to SN 31920	20 %				
<b>B10 value with high demand rate according to SN 31920</b>	1 000 000				
<b>Approvals Certificates</b>					
<b>General Product Approval</b>	<b>Functional Safety</b>				
					<a href="#">Type Examination Certificate</a>
CCC	EG-Konf.				
<b>Test Certificates</b>	<b>other</b>	<b>Environment</b>			



Further information

Information on the packaging

<https://support.industry.siemens.com/cs/ww/en/view/109813875>

Information for data generation and storage

<https://support.industry.siemens.com/cs/ww/en/view/109995012>

Information- and Downloadcenter (Catalogs, Brochures,...)

<https://www.siemens.com/ic10>

Industry Mall (Online ordering system)

<https://mall.industry.siemens.com/mall/en/en/Catalog/product?mlfb=3SE5312-3SG13>

Cax online generator

<https://support.automation.siemens.com/WW/CAXorder/default.aspx?lang=en&mlfb=3SE5312-3SG13>

Service&Support (Manuals, Certificates, Characteristics, FAQs,...)

<https://support.industry.siemens.com/cs/ww/en/ps/3SE5312-3SG13>

Image database (product images, 2D dimension drawings, 3D models, device circuit diagrams, EPLAN macros, ...)

[https://www.automation.siemens.com/bilddb/cax\\_de.aspx?mlfb=3SE5312-3SG13&lang=en](https://www.automation.siemens.com/bilddb/cax_de.aspx?mlfb=3SE5312-3SG13&lang=en)

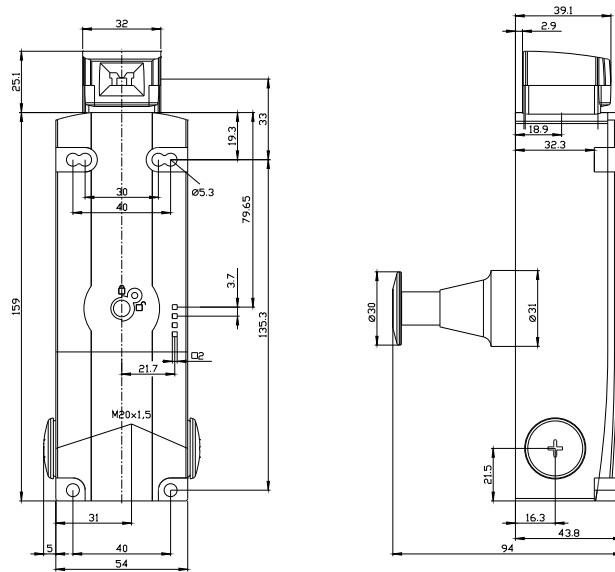

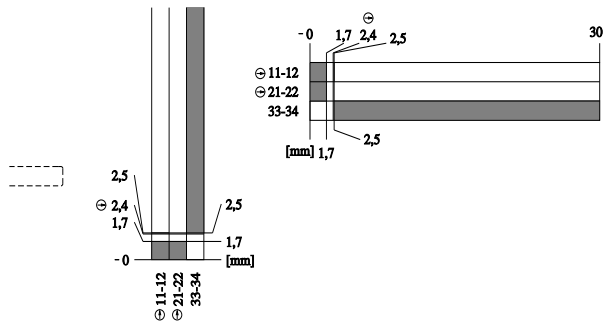

last modified:

4/2/2025