

Actuator head for position switch 3SE51/52 Angular roller lever Metal lever with Stainless steel roller 13 mm



product brand name	SIRIUS	
product designation	actuator head for position switch	
product type designation	3SE5	
manufacturer's article number		
<ul style="list-style-type: none"> of the supplied actuator head for position switches 	3SE5000-0AF11	
General technical data		
product function positive opening	Yes	
shock resistance		
<ul style="list-style-type: none"> according to IEC 60068-2-27 	30g / 11 ms	
vibration resistance		
<ul style="list-style-type: none"> according to IEC 60068-2-6 	0.35 mm/5g	
mechanical service life (operating cycles) typical	15 000 000	
material of the enclosure of the switch head	plastic	
reference code according to IEC 81346-2	T	
active principle	mechanical	
Substance Prohibition (Date)	07/01/2006	
Weight	0.028 kg	
minimum actuating force in directions of actuation	10 N	
Ambient conditions		
ambient temperature		
<ul style="list-style-type: none"> during operation during storage 	-25 ... +85 °C -40 ... +90 °C	
explosion protection category for dust	none	
Enclosure		
coating of the enclosure	Other types	
Drive Head		
design of the actuating element	Angular roller lever, metal lever, high-grade steel roller	
standard-compliant actuator head	EN 50047	
shape of the switch head	roller	
outer diameter of the switch head	13 mm	
Installation/ mounting/ dimensions		
mounting position	any	
fastening method	lockable plug-in fixing	
design of the interface for safety-related communication	without	
Communication/ Protocol		
design of the interface	without	
Approvals Certificates		
General Product Approval	Functional Safety	Test Certificates



[Type Examination Certificate](#)

[Type Test Certificates/Test Report](#)

other

Environment



[Confirmation](#)

[Environmental Confirmations](#)

Further information

Information on the packaging

<https://support.industry.siemens.com/cs/ww/en/view/109813875>

Information for data generation and storage

<https://support.industry.siemens.com/cs/ww/en/view/109995012>

Information- and Downloadcenter (Catalogs, Brochures,...)

<https://www.siemens.com/ic10>

Industry Mall (Online ordering system)

<https://mall.industry.siemens.com/mall/en/en/Catalog/product?mlfb=3SE5000-0AF11>

Cax online generator

<https://support.automation.siemens.com/WW/CAXorder/default.aspx?lang=en&mlfb=3SE5000-0AF11>

Service&Support (Manuals, Certificates, Characteristics, FAQs,...)

<https://support.industry.siemens.com/cs/ww/en/ps/3SE5000-0AF11>

Image database (product images, 2D dimension drawings, 3D models, device circuit diagrams, EPLAN macros, ...)

https://www.automation.siemens.com/bilddb/cax_de.aspx?mlfb=3SE5000-0AF11&lang=en

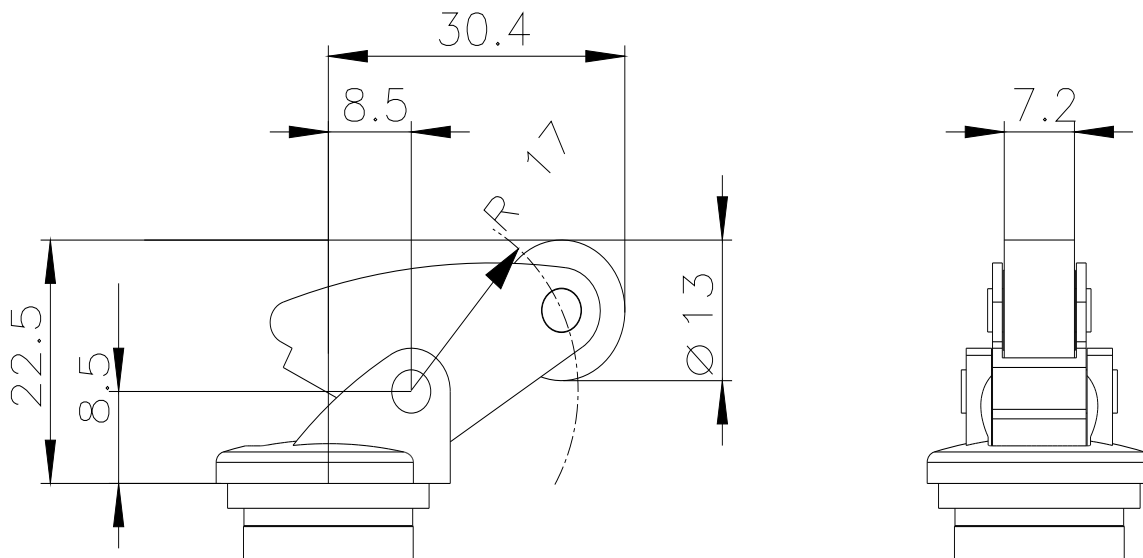

last modified:

4/2/2025