



power contactor, AC-3e/AC-3, 25 A, 11 kW / 400 V, 3-pole, 200-280 V AC/DC, 50/60 Hz, with integrated varistor, auxiliary contacts: 1 NO + 1 NC, screw terminal, size: S0

product brand name	SIRIUS
product designation	Power contactor
product type designation	3RT2
General technical data	
size of contactor	S0
product extension	
• function module for communication	No
• auxiliary switch	Yes
power loss [W] for rated value of the current	
• at AC in hot operating state	5.7 W
• at AC in hot operating state per pole	1.9 W
• without load current share typical	1.9 W
type of calculation of power loss depending on pole	quadratic
insulation voltage	
• of main circuit with degree of pollution 3 rated value	690 V
• of auxiliary circuit with degree of pollution 3 rated value	690 V
surge voltage resistance	
• of main circuit rated value	6 kV
• of auxiliary circuit rated value	6 kV
maximum permissible voltage for protective separation between coil and main contacts according to EN 60947-1	400 V
shock resistance at rectangular impulse	
• at AC	8,3g / 5 ms, 5,3g / 10 ms
• at DC	10g / 5 ms, 7,5g / 10 ms
shock resistance with sine pulse	
• at AC	13,5g / 5 ms, 8,3g / 10 ms
• at DC	15g / 5 ms, 10g / 10 ms
mechanical service life (operating cycles)	
• of contactor typical	10 000 000
• of the contactor with added electronically optimized auxiliary switch block typical	5 000 000
• of the contactor with added auxiliary switch block typical	10 000 000
reference code according to IEC 81346-2	Q
Substance Prohibitance (Date)	10/01/2009
SVHC substance name	Lead - 7439-92-1 Lead monoxide (lead oxide) - 1317-36-8
Weight	0.545 kg
Ambient conditions	
installation altitude at height above sea level maximum	2 000 m
ambient temperature	
• during operation	-25 ... +60 °C

• during storage	-55 ... +80 °C
relative humidity minimum	10 %
relative humidity at 55 °C according to IEC 60068-2-30 maximum	95 %
Environmental footprint	
Environmental Product Declaration(EPD)	Yes
global warming potential [CO2 eq] total	59.7 kg
global warming potential [CO2 eq] during manufacturing	3.7 kg
global warming potential [CO2 eq] during operation	56.6 kg
global warming potential [CO2 eq] after end of life	-0.626 kg
Main circuit	
number of poles for main current circuit	3
number of NO contacts for main contacts	3
number of NC contacts for main contacts	0
operating voltage	
• at AC-3 rated value maximum	690 V
• at AC-3e rated value maximum	690 V
operational current	
• at AC-1 at 400 V at ambient temperature 40 °C rated value	40 A
• at AC-1	
— up to 690 V at ambient temperature 40 °C rated value	40 A
— up to 690 V at ambient temperature 60 °C rated value	35 A
• at AC-3	
— at 400 V rated value	25 A
— at 500 V rated value	18 A
— at 690 V rated value	13 A
• at AC-3e	
— at 400 V rated value	25 A
— at 500 V rated value	18 A
— at 690 V rated value	13 A
• at AC-4 at 400 V rated value	15.5 A
• at AC-5a up to 690 V rated value	35.2 A
• at AC-5b up to 400 V rated value	20.7 A
• at AC-6a	
— up to 230 V for current peak value n=20 rated value	20.2 A
— up to 400 V for current peak value n=20 rated value	20.2 A
— up to 500 V for current peak value n=20 rated value	20.2 A
— up to 690 V for current peak value n=20 rated value	12.9 A
• at AC-6a	
— up to 230 V for current peak value n=30 rated value	13.5 A
— up to 400 V for current peak value n=30 rated value	13.5 A
— up to 500 V for current peak value n=30 rated value	13.5 A
— up to 690 V for current peak value n=30 rated value	13 A
minimum cross-section in main circuit at maximum AC-1 rated value	10 mm ²
operational current for approx. 200000 operating cycles at AC-4	
• at 400 V rated value	9 A
• at 690 V rated value	9 A
operational current	
• at 1 current path at DC-1	
— at 24 V rated value	35 A
— at 60 V rated value	20 A
— at 110 V rated value	4.5 A
— at 220 V rated value	1 A
— at 440 V rated value	0.4 A
— at 600 V rated value	0.25 A
• with 2 current paths in series at DC-1	
— at 24 V rated value	35 A

— at 60 V rated value	35 A
— at 110 V rated value	35 A
— at 220 V rated value	5 A
— at 440 V rated value	1 A
— at 600 V rated value	0.8 A
● with 3 current paths in series at DC-1	
— at 24 V rated value	35 A
— at 60 V rated value	35 A
— at 110 V rated value	35 A
— at 220 V rated value	35 A
— at 440 V rated value	2.9 A
— at 600 V rated value	1.4 A
● at 1 current path at DC-3 at DC-5	
— at 24 V rated value	20 A
— at 60 V rated value	5 A
— at 110 V rated value	2.5 A
— at 220 V rated value	1 A
— at 440 V rated value	0.09 A
— at 600 V rated value	0.06 A
● with 2 current paths in series at DC-3 at DC-5	
— at 24 V rated value	35 A
— at 60 V rated value	35 A
— at 110 V rated value	15 A
— at 220 V rated value	3 A
— at 440 V rated value	0.27 A
— at 600 V rated value	0.16 A
● with 3 current paths in series at DC-3 at DC-5	
— at 24 V rated value	35 A
— at 60 V rated value	35 A
— at 110 V rated value	35 A
— at 220 V rated value	10 A
— at 440 V rated value	0.6 A
— at 600 V rated value	0.6 A
operating power	
● at AC-3	
— at 230 V rated value	5.5 kW
— at 400 V rated value	11 kW
— at 500 V rated value	11 kW
— at 690 V rated value	11 kW
● at AC-3e	
— at 230 V rated value	5.5 kW
— at 400 V rated value	11 kW
— at 500 V rated value	11 kW
— at 690 V rated value	11 kW
operating power for approx. 200000 operating cycles at AC-4	
● at 400 V rated value	4.4 kW
● at 690 V rated value	7.7 kW
operating apparent power at AC-6a	
● up to 230 V for current peak value n=20 rated value	8 kVA
● up to 400 V for current peak value n=20 rated value	13.9 kVA
● up to 500 V for current peak value n=20 rated value	17.4 kVA
● up to 690 V for current peak value n=20 rated value	15.4 kVA
operating apparent power at AC-6a	
● up to 230 V for current peak value n=30 rated value	5.3 kVA
● up to 400 V for current peak value n=30 rated value	9.3 kVA
● up to 500 V for current peak value n=30 rated value	11.6 kVA
● up to 690 V for current peak value n=30 rated value	15.5 kVA
short-time withstand current in cold operating state up to 40 °C	
● limited to 1 s switching at zero current maximum	375 A; Use minimum cross-section acc. to AC-1 rated value

<ul style="list-style-type: none"> • limited to 5 s switching at zero current maximum • limited to 10 s switching at zero current maximum • limited to 30 s switching at zero current maximum • limited to 60 s switching at zero current maximum 	300 A; Use minimum cross-section acc. to AC-1 rated value 210 A; Use minimum cross-section acc. to AC-1 rated value 144 A; Use minimum cross-section acc. to AC-1 rated value 118 A; Use minimum cross-section acc. to AC-1 rated value
no-load switching frequency	
<ul style="list-style-type: none"> • at AC • at DC 	1 500 1/h 1 500 1/h
operating frequency	
<ul style="list-style-type: none"> • at AC-1 maximum • at AC-2 maximum • at AC-3 maximum • at AC-3e <ul style="list-style-type: none"> — maximum • at AC-4 maximum 	1 000 1/h 750 1/h 750 1/h 750 1/h 250 1/h
Control circuit/ Control	
type of voltage of the control supply voltage	AC/DC
control supply voltage at AC	
<ul style="list-style-type: none"> • at 50 Hz rated value • at 60 Hz rated value 	200 ... 280 V 200 ... 280 V
control supply voltage at DC rated value	200 ... 280 V
operating range factor control supply voltage rated value of magnet coil at DC	
<ul style="list-style-type: none"> • initial value • full-scale value 	0.7 1.1
operating range factor control supply voltage rated value of magnet coil at AC	
<ul style="list-style-type: none"> • at 50 Hz • at 60 Hz 	0.7 ... 1.1 0.7 ... 1.1
design of the surge suppressor	with varistor
inrush current peak	25 A
duration of inrush current peak	30 µs
locked-rotor current mean value	0.1 A
locked-rotor current peak	0.13 A
duration of locked-rotor current	180 ms
holding current mean value	17 mA
apparent pick-up power of magnet coil at AC	
<ul style="list-style-type: none"> • at 50 Hz • at 60 Hz 	12.7 VA 14.7 VA
inductive power factor with closing power of the coil	
<ul style="list-style-type: none"> • at 50 Hz • at 60 Hz 	0.98 0.98
apparent holding power	
<ul style="list-style-type: none"> • at minimum rated control supply voltage at DC • at maximum rated control supply voltage at DC 	1.9 VA 1.9 VA
apparent holding power	
<ul style="list-style-type: none"> • at minimum rated control supply voltage at AC <ul style="list-style-type: none"> — at 50 Hz — at 60 Hz • at maximum rated control supply voltage at AC <ul style="list-style-type: none"> — at 50 Hz — at 60 Hz 	3.9 VA 4.3 VA 3.9 VA 4.3 VA
apparent holding power of magnet coil at AC	
<ul style="list-style-type: none"> • at 50 Hz • at 60 Hz 	3.9 VA 4.3 VA
inductive power factor with the holding power of the coil	
<ul style="list-style-type: none"> • at 50 Hz • at 60 Hz 	0.51 0.56
closing power of magnet coil at DC	14.3 W
holding power of magnet coil at DC	1.9 W
closing delay	
<ul style="list-style-type: none"> • at AC 	50 ... 80 ms

<ul style="list-style-type: none"> • at DC 	50 ... 80 ms
opening delay	
<ul style="list-style-type: none"> • at AC 	30 ... 50 ms
<ul style="list-style-type: none"> • at DC 	30 ... 50 ms
arcing time	10 ... 10 ms
control version of the switch operating mechanism	Standard A1 - A2
Auxiliary circuit	
number of NC contacts for auxiliary contacts instantaneous contact	1
number of NO contacts for auxiliary contacts instantaneous contact	1
operational current at AC-12 maximum	10 A
operational current at AC-15	
<ul style="list-style-type: none"> • at 230 V rated value 	10 A
<ul style="list-style-type: none"> • at 400 V rated value 	3 A
<ul style="list-style-type: none"> • at 500 V rated value 	2 A
<ul style="list-style-type: none"> • at 690 V rated value 	1 A
operational current at DC-12	
<ul style="list-style-type: none"> • at 24 V rated value 	10 A
<ul style="list-style-type: none"> • at 48 V rated value 	6 A
<ul style="list-style-type: none"> • at 60 V rated value 	6 A
<ul style="list-style-type: none"> • at 110 V rated value 	3 A
<ul style="list-style-type: none"> • at 125 V rated value 	2 A
<ul style="list-style-type: none"> • at 220 V rated value 	1 A
<ul style="list-style-type: none"> • at 600 V rated value 	0.15 A
operational current at DC-13	
<ul style="list-style-type: none"> • at 24 V rated value 	10 A
<ul style="list-style-type: none"> • at 48 V rated value 	2 A
<ul style="list-style-type: none"> • at 60 V rated value 	2 A
<ul style="list-style-type: none"> • at 110 V rated value 	1 A
<ul style="list-style-type: none"> • at 125 V rated value 	0.9 A
<ul style="list-style-type: none"> • at 220 V rated value 	0.3 A
<ul style="list-style-type: none"> • at 600 V rated value 	0.1 A
contact reliability of auxiliary contacts	1 faulty switching per 100 million (17 V, 1 mA)
UL/CSA ratings	
full-load current (FLA) for 3-phase AC motor	
<ul style="list-style-type: none"> • at 480 V rated value 	21 A
<ul style="list-style-type: none"> • at 600 V rated value 	22 A
yielded mechanical performance [hp]	
<ul style="list-style-type: none"> • for single-phase AC motor <ul style="list-style-type: none"> — at 110/120 V rated value — at 230 V rated value 	2 hp 3 hp
<ul style="list-style-type: none"> • for 3-phase AC motor <ul style="list-style-type: none"> — at 200/208 V rated value — at 220/230 V rated value — at 460/480 V rated value — at 575/600 V rated value 	5 hp 7.5 hp 15 hp 20 hp
contact rating of auxiliary contacts according to UL	A600 / P600
Short-circuit protection	
design of the miniature circuit breaker for short-circuit protection of the auxiliary circuit up to 230 V	C characteristic: 10 A; 0.4 kA
design of the fuse link	
<ul style="list-style-type: none"> • for short-circuit protection of the main circuit <ul style="list-style-type: none"> — with type of coordination 1 required — with type of coordination 2 required • for short-circuit protection of the auxiliary switch required 	gG: 100 A (690 V, 100 kA), aM: 50 A (690 V, 100 kA), BS88: 100 A (415 V, 80 kA) gG: 35 A (690 V, 100 kA), aM: 20 A (690 V, 100 kA), BS88: 35 A (415 V, 80 kA) gG: 10 A (500 V, 1 kA)
Installation/ mounting/ dimensions	
mounting position	+/-180° rotation possible on vertical mounting surface; can be tilted forward and backward by +/- 22.5° on vertical mounting surface
fastening method side-by-side mounting	Yes
fastening method	screw and snap-on mounting onto 35 mm DIN rail according to DIN EN 60715

height	85 mm
width	45 mm
depth	107 mm
required spacing	
<ul style="list-style-type: none"> ● with side-by-side mounting <ul style="list-style-type: none"> — forwards 10 mm — upwards 10 mm — downwards 10 mm — at the side 0 mm ● for grounded parts <ul style="list-style-type: none"> — forwards 10 mm — upwards 10 mm — at the side 6 mm — downwards 10 mm ● for live parts <ul style="list-style-type: none"> — forwards 10 mm — upwards 10 mm — downwards 10 mm — at the side 6 mm 	
Connections/ Terminals	
type of electrical connection	
<ul style="list-style-type: none"> ● for main current circuit screw-type terminals ● for auxiliary and control circuit screw-type terminals ● at contactor for auxiliary contacts Screw-type terminals ● of magnet coil Screw-type terminals 	
type of connectable conductor cross-sections	
<ul style="list-style-type: none"> ● for main contacts <ul style="list-style-type: none"> — solid 2x (1 ... 2.5 mm²), 2x (2.5 ... 10 mm²) — solid or stranded 2x (1 ... 2.5 mm²), 2x (2.5 ... 10 mm²) — finely stranded with core end processing 2x (1 ... 2.5 mm²), 2x (2.5 ... 6 mm²), 1x 10 mm² ● for AWG cables for main contacts 2x (16 ... 12), 2x (14 ... 8) 	
connectable conductor cross-section for main contacts	
<ul style="list-style-type: none"> ● solid 1 ... 10 mm² ● stranded 1 ... 10 mm² ● finely stranded with core end processing 1 ... 10 mm² 	
connectable conductor cross-section for auxiliary contacts	
<ul style="list-style-type: none"> ● solid or stranded 0.5 ... 2.5 mm² ● finely stranded with core end processing 0.5 ... 2.5 mm² 	
type of connectable conductor cross-sections	
<ul style="list-style-type: none"> ● for auxiliary contacts <ul style="list-style-type: none"> — solid or stranded 2x (0.5 ... 1.5 mm²), 2x (0.75 ... 2.5 mm²) — finely stranded with core end processing 2x (0.5 ... 1.5 mm²), 2x (0.75 ... 2.5 mm²) ● for AWG cables for auxiliary contacts 2x (20 ... 16), 2x (18 ... 14) 	
AWG number as coded connectable conductor cross section for main contacts	16 ... 8
AWG number as coded connectable conductor cross section for auxiliary contacts	20 ... 14
Safety related data	
product function	
<ul style="list-style-type: none"> ● mirror contact according to IEC 60947-4-1 Yes ● positively driven operation according to IEC 60947-5-1 No ● suitable for safety function Yes 	
suitability for use safety-related switching OFF	Yes
service life maximum	20 a
test wear-related service life necessary	Yes
proportion of dangerous failures	
<ul style="list-style-type: none"> ● with low demand rate according to SN 31920 40 % ● with high demand rate according to SN 31920 73 % 	
B10 value with high demand rate according to SN 31920	1 000 000
failure rate [FIT] with low demand rate according to SN 31920	100 FIT

ISO 13849	
device type according to ISO 13849-1	3
overdimensioning according to ISO 13849-2 necessary	Yes
IEC 61508	
safety device type according to IEC 61508-2	Type A
Electrical Safety	
protection class IP on the front according to IEC 60529	IP20
touch protection on the front according to IEC 60529	finger-safe, for vertical contact from the front

Approvals Certificates

General Product Approval







[KC](#)

General Product Approval	EMV	Test Certificates	Maritime application
--------------------------	-----	-------------------	----------------------





RCM

[Special Test Certificate](#)

[Type Test Certificates/Test Report](#)

[Miscellaneous](#)



ABS

Maritime application	other
----------------------	-------





DNV



LRS



RINA



RMRS

[Miscellaneous](#)

other	Railway	Dangerous goods	Environment
-------	---------	-----------------	-------------



[Confirmation](#)

[Confirmation](#)

[Special Test Certificate](#)

[Transport Information](#)



Environment

[Environmental Confirmations](#)

Further information

- Information on the packaging
<https://support.industry.siemens.com/cs/ww/en/view/109813875>
- Information for data generation and storage
<https://support.industry.siemens.com/cs/ww/en/view/109995012>
- Information- and Downloadcenter (Catalogs, Brochures,...)
<https://www.siemens.com/ic10>
- Industry Mall (Online ordering system)
<https://mall.industry.siemens.com/mall/en/en/Catalog/product?mlfb=3RT2026-1NP30>
- Cax online generator
<https://support.automation.siemens.com/WW/CAXorder/default.aspx?lang=en&mlfb=3RT2026-1NP30>
- Service&Support (Manuals, Certificates, Characteristics, FAQs,...)
<https://support.industry.siemens.com/cs/ww/en/ps/3RT2026-1NP30>
- Image database (product images, 2D dimension drawings, 3D models, device circuit diagrams, EPLAN macros, ...)
https://www.automation.siemens.com/bilddb/cax_de.aspx?mlfb=3RT2026-1NP30&lang=en
- Characteristic: Tripping characteristics, I²t, Let-through current
<https://support.industry.siemens.com/cs/ww/en/ps/3RT2026-1NP30/char>
- Further characteristics (e.g. electrical endurance, switching frequency)
<https://www.automation.siemens.com/bilddb/index.aspx?view=Search&mlfb=3RT2026-1NP30&objecttype=14&gridview=view1>

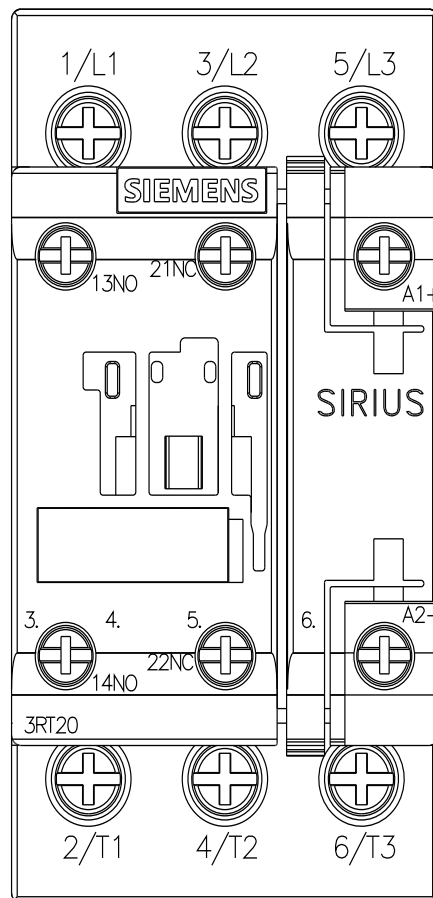
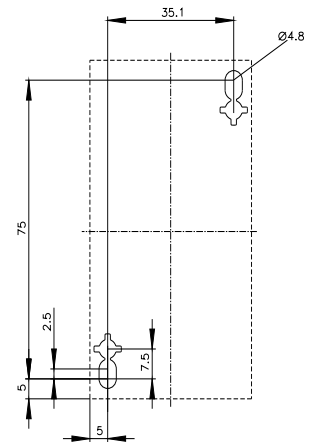
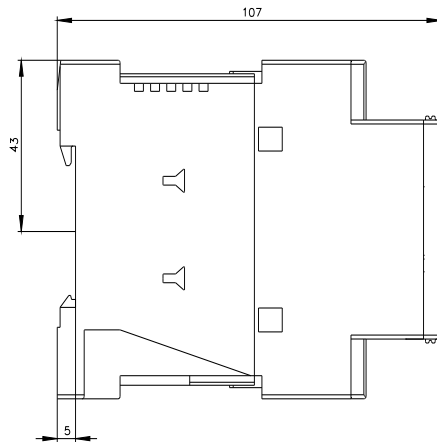
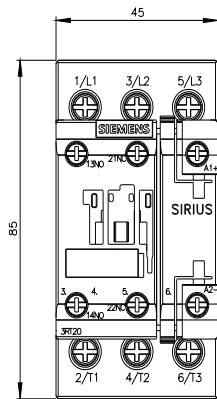



last modified:

10/21/2025 