







Surge suppressor (RC element) For 3RT1 S6, S10, S12 With screw terminal (operating mechanism) 24...48 V AC, 24...70 V DC

product brand name	SIRIUS	
product category	Surge suppressor	
product designation	RC element	
product type designation	3RT19	
suitability for use	for 3RT1.5, 3RT1.6 and 3RT1.7 contactors	
General technical data		
certificate of suitability	CE / UL / CSA	
Substance Prohibitance (Date)	07/01/2006	
Weight	0.033 kg	
type of voltage of the control supply voltage	AC/DC	
control supply voltage at AC		
• at 50 Hz rated value	24 ... 48 V	
• at 60 Hz rated value	24 ... 48 V	
control supply voltage frequency		
• 1 rated value	50 Hz	
• 2 rated value	60 Hz	
control supply voltage at DC rated value	24 ... 70 V	
design of the surge suppressor	RC element	
Ambient conditions		
ambient temperature		
• during operation	-25 ... +60 °C	
• during storage	-40 ... +80 °C	
Environmental footprint		
Environmental Product Declaration (EPD)	Yes	
global warming potential [CO2 eq] total	23.4 kg	
global warming potential [CO2 eq] during manufacturing	0.187 kg	
global warming potential [CO2 eq] during operation	23.2 kg	
global warming potential [CO2 eq] after end of life	0.014 kg	
Approvals Certificates		
General Product Approval	EMV	Test Certificates
 EG-Konf.		 UR
		Special Test Certificate
Maritime application	other	



[Confirmation](#)

other Railway Environment

[Miscellaneous](#)

[Special Test Certificate](#)



[Environmental Confirmations](#)

Further information

Information on the packaging

<https://support.industry.siemens.com/cs/ww/en/view/109813875>

Information for data generation and storage

<https://support.industry.siemens.com/cs/ww/en/view/109995012>

Information- and Downloadcenter (Catalogs, Brochures,...)

<https://www.siemens.com/ic10>

Industry Mall (Online ordering system)

<https://mall.industry.siemens.com/mall/en/en/Catalog/product?mlfb=3RT1956-1CB00>

Cax online generator

<https://support.automation.siemens.com/WW/CAXorder/default.aspx?lang=en&mlfb=3RT1956-1CB00>

Service&Support (Manuals, Certificates, Characteristics, FAQs,...)

<https://support.industry.siemens.com/cs/ww/en/ps/3RT1956-1CB00>

Image database (product images, 2D dimension drawings, 3D models, device circuit diagrams, EPLAN macros, ...)

https://www.automation.siemens.com/bilddb/cax_de.aspx?mlfb=3RT1956-1CB00&lang=en

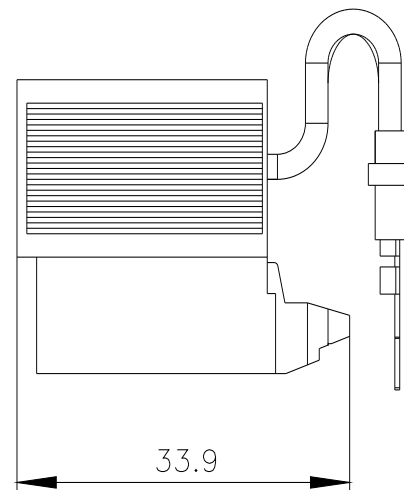
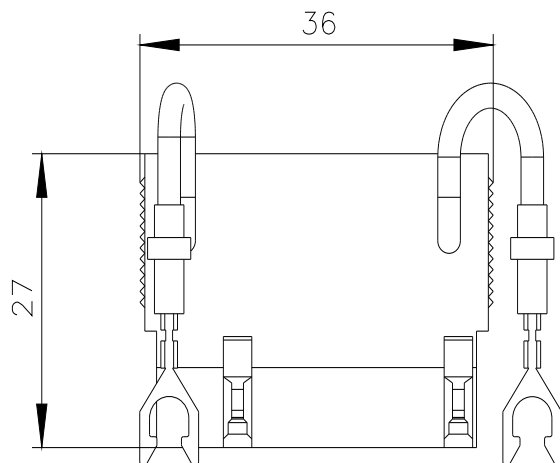



last modified:

4/2/2025 