



Fail-safe direct starter, 3RM1, 500 V, 0.55 - 3 kW, 1.6 - 7 A, 24 V DC, screw terminals

product brand name	SIRIUS
product category	Motor starter
product designation	Fail-safe direct starter
design of the product	With electronic overload protection and safety-related disconnection
product type designation	3RM1
<b>General technical data</b>	
equipment version according to IEC 60947-4-2	3
product function	fail-safe direct starter
<ul style="list-style-type: none"> <li>intrinsic device protection</li> </ul>	Yes
<ul style="list-style-type: none"> <li>for power supply reverse polarity protection</li> </ul>	Yes
suitability for operation device connector 3ZY12	Yes
power loss [W] for rated value of the current	
<ul style="list-style-type: none"> <li>at AC in hot operating state per pole</li> </ul>	1.13 W
<ul style="list-style-type: none"> <li>without load current share typical</li> </ul>	1.37 W
insulation voltage rated value	500 V
overvoltage category	III
surge voltage resistance rated value	6 kV
maximum permissible voltage for protective separation	
<ul style="list-style-type: none"> <li>between main and auxiliary circuit</li> </ul>	500 V
<ul style="list-style-type: none"> <li>between control and auxiliary circuit</li> </ul>	250 V
shock resistance	6g / 11 ms
vibration resistance	1 ... 6 Hz, 15 mm; 20 m/s <sup>2</sup> , 500 Hz
operating frequency maximum	1 1/s
reference code according to IEC 81346-2	Q
Substance Prohibitance (Date)	03/01/2017
SVHC substance name	Lead - 7439-92-1 Lead monoxide (lead oxide) - 1317-36-8 2,2',6,6'-tetrabromo-4,4'-isopropylidenediphenol - 79-94-7 6,6'-di-tert-butyl-2,2'-methylenedi-p-cresol - 119-47-1
Weight	0.307 kg
product function	
<ul style="list-style-type: none"> <li>direct start</li> </ul>	Yes
<ul style="list-style-type: none"> <li>reverse starting</li> </ul>	No
product function short circuit protection	No
<b>Electromagnetic compatibility</b>	
EMC emitted interference according to IEC 60947-1	class A
EMC immunity according to IEC 60947-1	Class A
conducted interference	
<ul style="list-style-type: none"> <li>due to burst according to IEC 61000-4-4</li> </ul>	3 kV / 5 kHz
<ul style="list-style-type: none"> <li>due to conductor-earth surge according to IEC 61000-4-5</li> </ul>	4 kV signal lines 2 kV
<ul style="list-style-type: none"> <li>due to conductor-conductor surge according to IEC</li> </ul>	2 kV

61000-4-5	
<ul style="list-style-type: none"> <li>due to high-frequency radiation according to IEC 61000-4-6</li> </ul>	10 V
<b>field-based interference according to IEC 61000-4-3</b>	10 V/m
<b>electrostatic discharge according to IEC 61000-4-2</b>	6 kV contact discharge / 8 kV air discharge
<b>conducted HF interference emissions according to CISPR11</b>	Class B for the domestic, business and commercial environments
<b>field-bound HF interference emission according to CISPR11</b>	Class B for the domestic, business and commercial environments
<b>Safety related data</b>	
<b>safe state</b>	Load circuit open
<b>function test interval maximum</b>	1 a
<b>diagnostics test interval by internal test function maximum</b>	600 s
<b>stop category according to IEC 60204-1</b>	0
<b>B10d value</b>	2 500 000
<b>failure rate [FIT] at rate of recognizable hazardous failures (<math>\lambda_{dd}</math>)</b>	1 400 FIT
<b>failure rate [FIT] at rate of non-recognizable hazardous failures (<math>\lambda_{du}</math>)</b>	16 FIT
<b>average diagnostic coverage level (DCavg)</b>	99 %
<b>MTTFd</b>	75 a
<b>IEC 62061</b>	
<b>Safety Integrity Level (SIL) according to IEC 62061</b>	SIL 3
PFHD with high demand rate according to IEC 62061	2E-8 1/h
<b>ISO 13849</b>	
<b>performance level (PL) according to ISO 13849-1</b>	PL e
<b>IEC 61508</b>	
<b>Safety Integrity Level (SIL)</b>	
<ul style="list-style-type: none"> <li>according to IEC 61508</li> </ul>	3
<b>safety device type according to IEC 61508-2</b>	Type B
PFDAvg with low demand rate according to IEC 61508	1.75E-5
<b>Safe failure fraction (SFF)</b>	99.4 %
hardware fault tolerance according to IEC 61508	1
T1 value for proof test interval or service life according to IEC 61508	20 a
<b>Electrical Safety</b>	
<b>protection class IP on the front according to IEC 60529</b>	IP20
<b>touch protection on the front according to IEC 60529</b>	finger-safe
<b>ATEX</b>	
<b>Safety Integrity Level (SIL) according to IEC 61508 relating to ATEX</b>	SIL 2
PFHD with high demand rate according to IEC 61508 relating to ATEX	5E-8 1/h
PFDAvg with low demand rate according to IEC 61508 relating to ATEX	0.0005
hardware fault tolerance according to IEC 61508 relating to ATEX	0
T1 value for proof test interval or service life according to IEC 61508 relating to ATEX	3 a
certificate of suitability according to ATEX directive 2014/34/EU	BVS 12 ATEX F 002 X
<b>type of protection according to ATEX directive 2014/34/EU</b>	II (2)G [Ex e] [Ex d] [Ex px], II (2)D [Ex t] [Ex p], I (M2) [Ex d]
<b>Main circuit</b>	
<b>number of poles for main current circuit</b>	3
<b>design of the switching contact</b>	Hybrid
<b>adjustable current response value current of the current-dependent overload release</b>	1.6 ... 7 A
<b>minimum load [%]</b>	20 %; from set rated current
<b>type of the motor protection</b>	solid-state
operating voltage rated value	48 ... 500 V
<b>relative symmetrical tolerance of the operating voltage</b>	10 %
<b>operating frequency 1 rated value</b>	50 Hz
<b>operating frequency 2 rated value</b>	60 Hz
<b>relative symmetrical tolerance of the operating frequency</b>	10 %
<b>operational current</b>	
<ul style="list-style-type: none"> <li>at AC at 400 V rated value</li> </ul>	7 A

<ul style="list-style-type: none"> <li>• at AC-3 at 400 V rated value</li> </ul>	7 A
<ul style="list-style-type: none"> <li>• at AC-53a at 400 V at ambient temperature 40 °C rated value</li> </ul>	7 A
<b>ampacity when starting maximum</b>	56 A
operating power for 3-phase motors at 400 V at 50 Hz	0.55 ... 3 kW
<b>derating temperature</b>	40 °C
<b>Inputs/ Outputs</b>	
input voltage at digital input at DC rated value	24 V
<b>input current at digital input</b>	
<ul style="list-style-type: none"> <li>• for signal &lt;1&gt; at DC</li> </ul>	8 mA
<ul style="list-style-type: none"> <li>• with signal &lt;0&gt; at DC</li> </ul>	1 mA
number of CO contacts for auxiliary contacts	1
<b>operational current of auxiliary contacts at AC-15 at 230 V maximum</b>	3 A
<b>operational current of auxiliary contacts at DC-13 at 24 V maximum</b>	1 A
<b>Control circuit/ Control</b>	
<b>type of voltage of the control supply voltage</b>	DC
<b>control supply voltage at DC rated value</b>	19.2 ... 30 V
<b>relative negative tolerance of the control supply voltage at DC</b>	20 %
<b>relative positive tolerance of the control supply voltage at DC</b>	25 %
<b>control supply voltage 1 at DC rated value</b>	24 V
<b>operating range factor control supply voltage rated value at DC</b>	
<ul style="list-style-type: none"> <li>• initial value</li> </ul>	0.8
<ul style="list-style-type: none"> <li>• full-scale value</li> </ul>	1.25
<b>control current at DC</b>	
<ul style="list-style-type: none"> <li>• in standby mode of operation</li> </ul>	13 mA
<ul style="list-style-type: none"> <li>• during operation</li> </ul>	57 mA
<b>inrush current peak</b>	
<ul style="list-style-type: none"> <li>• at 24 V</li> </ul>	0.28 A; values at 25 °C
<ul style="list-style-type: none"> <li>• at DC at 24 V</li> </ul>	300 mA
<ul style="list-style-type: none"> <li>• at DC at 24 V at switching on of motor</li> </ul>	130 mA
<b>duration of inrush current peak</b>	
<ul style="list-style-type: none"> <li>• at 24 V</li> </ul>	85 ms
<ul style="list-style-type: none"> <li>• at DC at 24 V</li> </ul>	80 ms
<ul style="list-style-type: none"> <li>• at DC at 24 V at switching on of motor</li> </ul>	20 ms
<b>power loss [W] in auxiliary and control circuit</b>	
<ul style="list-style-type: none"> <li>• <b>in switching state OFF</b> <ul style="list-style-type: none"> <li>— with bypass circuit</li> </ul> </li> </ul>	0.35 W
<ul style="list-style-type: none"> <li>• <b>in switching state ON</b> <ul style="list-style-type: none"> <li>— with bypass circuit</li> </ul> </li> </ul>	1.37 W
<b>Response times</b>	
<b>ON-delay time</b>	65 ... 76 ms
<b>OFF-delay time</b>	30 ... 43 ms
<b>Power Electronics</b>	
<b>operational current</b>	
<ul style="list-style-type: none"> <li>• at 40 °C rated value</li> </ul>	7 A
<ul style="list-style-type: none"> <li>• at 50 °C rated value</li> </ul>	6.1 A
<ul style="list-style-type: none"> <li>• at 55 °C rated value</li> </ul>	5.2 A
<ul style="list-style-type: none"> <li>• at 60 °C rated value</li> </ul>	4.6 A
<b>Installation/ mounting/ dimensions</b>	
<b>mounting position</b>	vertical, horizontal, standing (observe derating)
<b>fastening method</b>	screw and snap-on mounting onto 35 mm DIN rail
<b>height</b>	100 mm
<b>width</b>	22.5 mm
<b>depth</b>	141.6 mm
<b>required spacing</b>	
<ul style="list-style-type: none"> <li>• with side-by-side mounting <ul style="list-style-type: none"> <li>— forwards</li> </ul> </li> </ul>	0 mm

— backwards	0 mm
— upwards	50 mm
— downwards	50 mm
— at the side	0 mm
● for grounded parts	
— forwards	0 mm
— backwards	0 mm
— upwards	50 mm
— at the side	3.5 mm
— downwards	50 mm

#### Ambient conditions

installation altitude at height above sea level maximum	4 000 m; For derating see manual
<b>ambient temperature</b>	
● during operation	-25 ... +60 °C
● during storage	-40 ... +70 °C
● during transport	-40 ... +70 °C
environmental category during operation according to IEC 60721	3K6 (no ice formation, only occasional condensation), 3C3 (no salt mist), 3S2 (sand must not get into the devices), 3M6
relative humidity during operation	10 ... 95 %
air pressure according to SN 31205	900 ... 1 060 hPa

#### Communication/ Protocol

<b>protocol is supported</b>	
● PROFINET IO protocol	No
● PROFI-safe protocol	No
<b>product function bus communication</b>	No
protocol is supported AS-Interface protocol	No

#### Connections/ Terminals

<b>type of electrical connection</b>	screw-type terminals for main circuit, screw-type terminals for control circuit
● for main current circuit	screw-type terminals
● for auxiliary and control circuit	screw-type terminals
<b>wire length for motor unshielded maximum</b>	100 m
type of connectable conductor cross-sections for main contacts	
● solid	1x (0,5 ... 4 mm <sup>2</sup> ), 2x (0,5 ... 2,5 mm <sup>2</sup> )
● finely stranded with core end processing	1x (0,5 ... 4 mm <sup>2</sup> ), 2x (0,5 ... 1,5 mm <sup>2</sup> )
<b>connectable conductor cross-section for main contacts</b>	
● solid or stranded	0.5 ... 4 mm <sup>2</sup>
● finely stranded with core end processing	0.5 ... 4 mm <sup>2</sup>
<b>connectable conductor cross-section for auxiliary contacts</b>	
● solid or stranded	0.5 ... 2.5 mm <sup>2</sup>
● finely stranded with core end processing	0.5 ... 2.5 mm <sup>2</sup>
<b>type of connectable conductor cross-sections</b>	
● for auxiliary contacts	
— solid	1x (0,5 ... 2,5 mm <sup>2</sup> ), 2x (1,0 ... 1,5 mm <sup>2</sup> )
— finely stranded with core end processing	1x (0,5 ... 2,5 mm <sup>2</sup> ), 2x (0,5 ... 1 mm <sup>2</sup> )
● for AWG cables for auxiliary contacts	1x (20 ... 14), 2x (18 ... 16)
<b>AWG number as coded connectable conductor cross section</b>	
● for main contacts	20 ... 12
● for auxiliary contacts	20 ... 14



#### UL/CSA ratings

<b>yielded mechanical performance [hp]</b>	
● for single-phase AC motor	
— at 110/120 V rated value	0.25 hp
— at 230 V rated value	0.5 hp
● for 3-phase AC motor	
— at 200/208 V rated value	1 hp
— at 220/230 V rated value	1.5 hp
— at 460/480 V rated value	3 hp
<b>operational current at AC at 480 V according to UL 508</b>	6.1 A

#### Approvals Certificates

General Product Approval	EMV
--------------------------	-----



For use in hazardous locations	Functional Safety	Test Certificates	other		Railway
	<a href="#">Type Examination Certificate</a>	<a href="#">Type Test Certificates/Test Report</a>		<a href="#">Confirmation</a>	<a href="#">Special Test Certificate</a>

#### Environment

[Environmental Confirmations](#)

#### Further information

Information on the packaging

<https://support.industry.siemens.com/cs/ww/en/view/109813875>

Information for data generation and storage

<https://support.industry.siemens.com/cs/ww/en/view/109995012>

Information- and Downloadcenter (Catalogs, Brochures,...)

<https://www.siemens.com/ic10>

Industry Mall (Online ordering system)

<https://mall.industry.siemens.com/mall/en/en/Catalog/product?mlfb=3RM1107-1AA04>

Cax online generator

<https://support.automation.siemens.com/WW/CAXorder/default.aspx?lang=en&mlfb=3RM1107-1AA04>

Service&Support (Manuals, Certificates, Characteristics, FAQs,...)

<https://support.industry.siemens.com/cs/ww/en/ps/3RM1107-1AA04>

Image database (product images, 2D dimension drawings, 3D models, device circuit diagrams, EPLAN macros, ...)

[https://www.automation.siemens.com/bilddb/cax\\_de.aspx?mlfb=3RM1107-1AA04&lang=en](https://www.automation.siemens.com/bilddb/cax_de.aspx?mlfb=3RM1107-1AA04&lang=en)

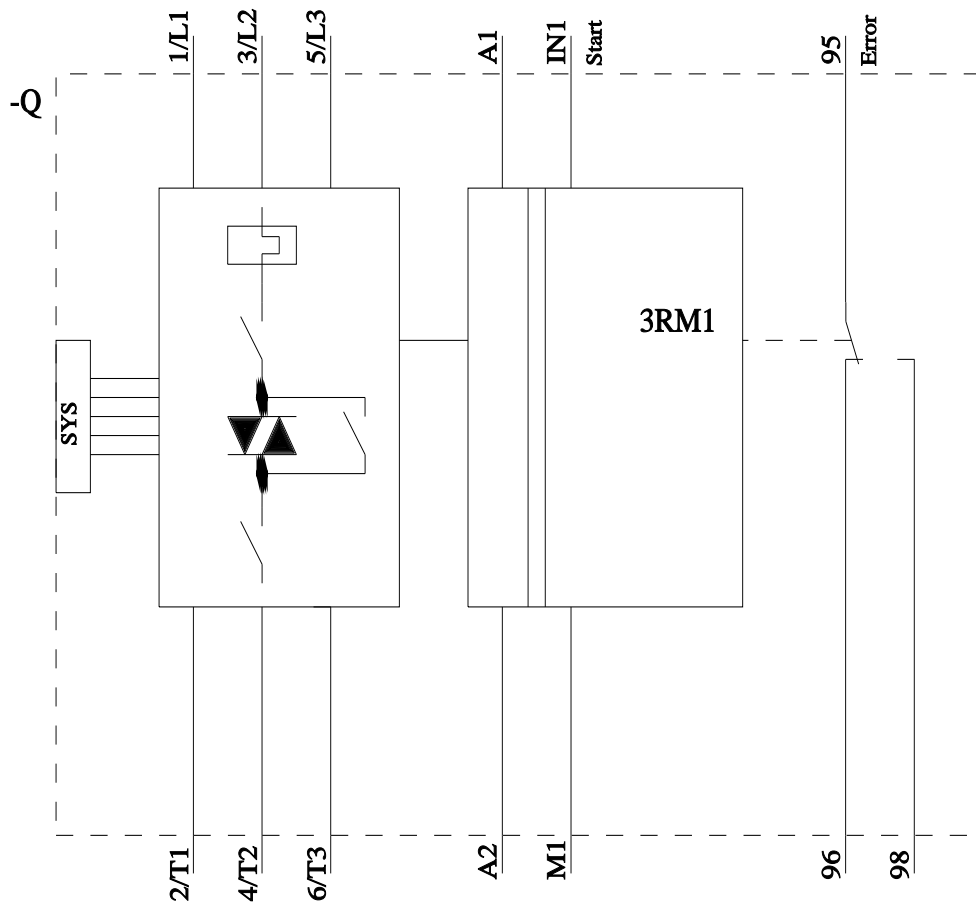
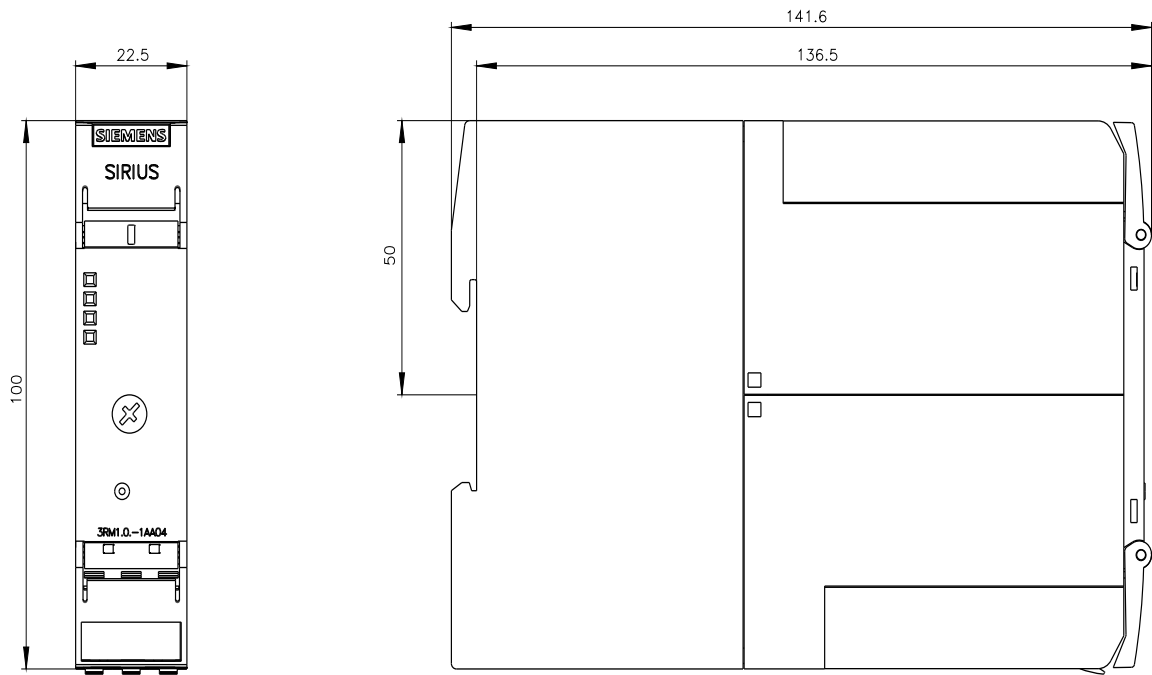

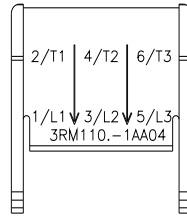
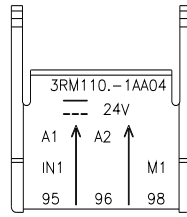
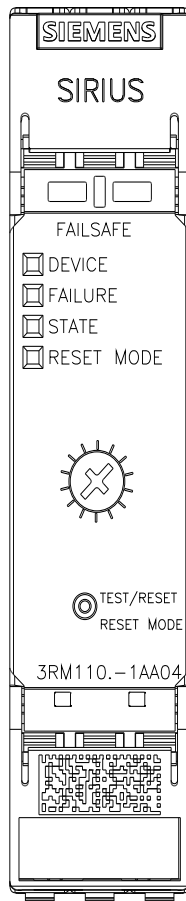

last modified:

9/5/2025