







Solid-state contactor 3-phase 3RF2 AC 51 / 20 A / 40 °C 48-600 V / 230 V AC 2-phase controlled screw terminal Blocking voltage 1200 V

product brand name	SIRIUS
product designation	solid-state contactor
design of the product	2-pole controlled
product type designation	3RF24
General technical data	
product function	zero-point switching
power loss [W] for rated value of the current	
• at AC in hot operating state	44 W
• at AC in hot operating state per pole	14.67 W
• without load current share typical	3.5 W
insulation voltage rated value	600 V
degree of pollution	3
surge voltage resistance of main circuit rated value	6 kV
protection class IP	IP20
protection class IP on the front according to IEC 60529	IP20
shock resistance according to IEC 60068-2-27	15g / 11 ms
vibration resistance according to IEC 60068-2-6	2g
reference code according to IEC 81346-2	Q
Substance Prohibitance (Date)	07/01/2006
SVHC substance name	Lead - 7439-92-1 Lead monoxide (lead oxide) - 1317-36-8 Dibutylbis(pentane-2,4-dionato-O,O')tin - 22673-19-4
Weight	0.345 kg
Main circuit	
number of poles for main current circuit	3
number of NO contacts for main contacts	2
number of NC contacts for main contacts	0
type of voltage of the operating voltage	AC
operating voltage	
• at AC	
— at 50 Hz rated value	48 ... 600 V
— at 60 Hz rated value	48 ... 600 V
operating frequency rated value	50 ... 60 Hz
relative symmetrical tolerance of the operating frequency	10 %
operating range relative to the operating voltage at AC	
• at 50 Hz	40 ... 660 V
• at 60 Hz	40 ... 660 V
operational current	
• at AC-51 rated value	22 A
• at AC-51 according to IEC 60947-4-3	15 A
• according to UL 508 rated value	15 A

operational current minimum	500 mA
rate of voltage rise at the thyristor for main contacts maximum permissible	1 000 V/ μ s
blocking voltage at the thyristor for main contacts maximum permissible	1 200 V
reverse current of the thyristor	10 mA
derating temperature	40 °C
surge current resistance rated value	600 A
I²t value maximum	1 800 A ² ·s
Control circuit/ Control	
type of voltage of the control supply voltage	AC
control supply voltage 1 at AC	
• at 50 Hz	180 ... 230 V
• at 60 Hz	180 ... 230 V
control supply voltage frequency	
• 1 rated value	45 Hz
• 2 rated value	66 Hz
control supply voltage at AC	
• at 50 Hz full-scale value for signal<0> recognition	40 V
• at 60 Hz full-scale value for signal<0> recognition	180 V
control supply voltage	
• at AC initial value for signal <1> detection	180 V
symmetrical line frequency tolerance	5 Hz
control current at minimum control supply voltage	
• at AC	2 mA
control current at AC rated value	15 mA
ON-delay time	40 ms; additionally max. one half-wave
Auxiliary circuit	
type of switching contact	normally open contact (NO)
number of NC contacts for auxiliary contacts	0
number of NO contacts for auxiliary contacts	0
number of CO contacts for auxiliary contacts	0
Installation/ mounting/ dimensions	
fastening method side-by-side mounting	Yes
fastening method	screw fixing and snap-on mounting on standard mounting rail 35 mm according to IEC 60715
design of the thread of the screw for securing the equipment	M4
height	100 mm
width	45 mm
depth	117 mm
Connections/ Terminals	
product component removable terminal for auxiliary and control circuit	Yes
type of electrical connection	
• for main current circuit	screw-type terminals
• for auxiliary and control circuit	screw-type terminals
type of connectable conductor cross-sections	
• for main contacts	
— solid	2x (1.5 ... 2.5 mm ²), 2x (2.5 ... 6 mm ²)
— finely stranded with core end processing	2x (1 ... 2.5 mm ²), 2x (2.5 ... 6 mm ²), 1x 10 mm ²
• for AWG cables for main contacts	2x (14 ... 10)
connectable conductor cross-section for main contacts	
• solid or stranded	0.5 ... 2.5 mm ²
• finely stranded with core end processing	0.5 ... 1.5 mm ²
• finely stranded without core end processing	0.5 ... 2.5 mm ²
type of connectable conductor cross-sections	
• for auxiliary and control contacts	
— solid	1x (0.5 ... 2.5 mm ²), 2x (0.5 ... 1 mm ²)
— finely stranded with core end processing	1x (0.5 ... 2.5 mm ²), 2x (0.5 ... 1 mm ²)
— finely stranded without core end processing	1x (0.5 ... 2.5 mm ²), 2x (0.5 ... 1 mm ²)
• for AWG cables for auxiliary and control contacts	1x (20 ... 12)

AWG number as coded connectable conductor cross section for main contacts	14 ... 10				
tightening torque					
<ul style="list-style-type: none"> for main contacts with screw-type terminals for auxiliary and control contacts with screw-type terminals 	2 ... 2.5 N-m 0.5 ... 0.6 N-m				
tightening torque [lbf-in]					
<ul style="list-style-type: none"> for main contacts with screw-type terminals for auxiliary and control contacts with screw-type terminals 	18 ... 22 lbf-in 7.5 ... 5.3 lbf-in				
design of the thread of the connection screw					
<ul style="list-style-type: none"> for main contacts of the auxiliary and control contacts 	M4 M3				
stripped length of the cable					
<ul style="list-style-type: none"> for main contacts for auxiliary and control contacts 	10 mm 7 mm				
Electrical Safety					
protection class IP on the front according to IEC 60529	IP20				
touch protection on the front according to IEC 60529	finger-safe, for vertical contact from the front				
Ambient conditions					
installation altitude at height above sea level maximum	1 000 m				
ambient temperature					
<ul style="list-style-type: none"> during operation during storage 	-25 ... +60 °C -55 ... +80 °C				
Electromagnetic compatibility					
conducted interference					
<ul style="list-style-type: none"> due to burst according to IEC 61000-4-4 due to conductor-earth surge according to IEC 61000-4-5 due to conductor-conductor surge according to IEC 61000-4-5 due to high-frequency radiation according to IEC 61000-4-6 	2 kV / 5 kHz behavior criterion 2 2 kV behavior criterion 2 1 kV behavior criterion 2 140 dBuV in the frequency range 0.15 ... 80 MHz, behavior criterion 1				
electrostatic discharge according to IEC 61000-4-2	4 kV contact discharging / 8 kV air discharging, behavior criterion 2				
conducted HF interference emissions according to CISPR11	Class A for industrial environment				
field-bound HF interference emission according to CISPR11	Class A for industrial environment				
Short-circuit protection, design of the fuse link					
manufacturer's article number <ul style="list-style-type: none"> of full range R fuse link for semiconductor protection at NH design usable of full range R fuse link for semiconductor protection at cylindrical design usable of back-up R fuse link for semiconductor protection at NH design usable of back-up R fuse link for semiconductor protection at cylindrical design 10 x 38 mm usable of back-up R fuse link for semiconductor protection at cylindrical design 14 x 51 mm usable of back-up R fuse link for semiconductor protection at cylindrical design 22 x 58 mm usable 	3NE1814-0 5SE1320: Maximum operating voltage 400 V! 3NE8015-1 3NC1032 3NC1450 3NC2250				
manufacturer's article number of the gG fuse at NH design usable <ul style="list-style-type: none"> up to 460 V 	3NA3805: These fuses have a smaller rated current than the semiconductor relays				
Approvals Certificates					
General Product Approval	EMV	Test Certificates			
 EG-Konf.		 UL		 RCM	Type Test Certificates/Test Report
other	Environment				



Confirmation



Environmental Confirmations

Further information

Information on the packaging

<https://support.industry.siemens.com/cs/ww/en/view/109813875>

Information for data generation and storage

<https://support.industry.siemens.com/cs/ww/en/view/109995012>

Information- and Downloadcenter (Catalogs, Brochures,...)

<https://www.siemens.com/ic10>

Industry Mall (Online ordering system)

<https://mall.industry.siemens.com/mall/en/en/Catalog/product?mlfb=3RF2420-1AB55>

Cax online generator

<https://support.automation.siemens.com/WW/CAXorder/default.aspx?lang=en&mlfb=3RF2420-1AB55>

Service&Support (Manuals, Certificates, Characteristics, FAQs,...)

<https://support.industry.siemens.com/cs/ww/en/ps/3RF2420-1AB55>

Image database (product images, 2D dimension drawings, 3D models, device circuit diagrams, EPLAN macros, ...)

https://www.automation.siemens.com/bilddb/cax_de.aspx?mlfb=3RF2420-1AB55&lang=en

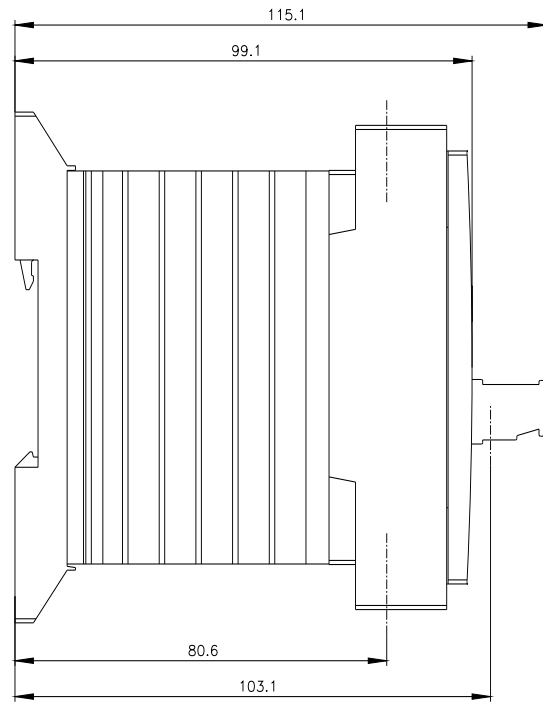
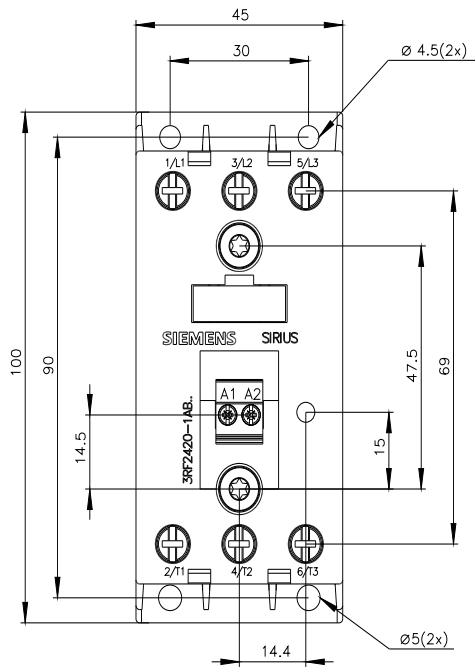

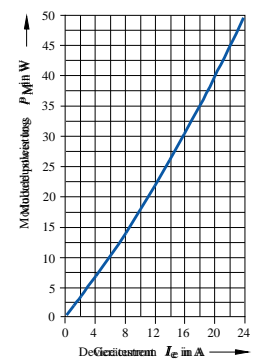
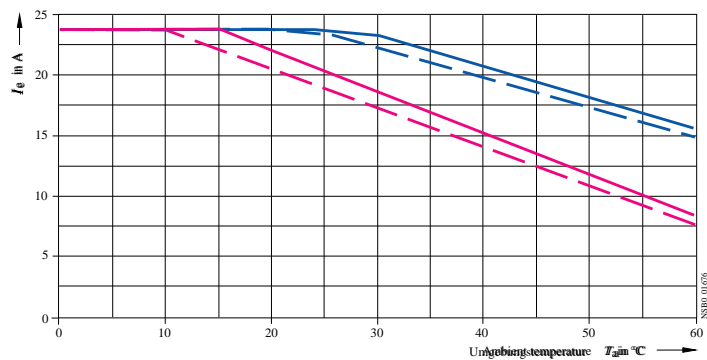

- I_{max} Thermischer Grenzstrom bei Einzelaufstellung
- - I_{max} Thermischer Grenzstrom bei Dicht-an-Dicht-Montage
- I_{IEC} Strom nach IEC 947-4-3 bei Einzelaufstellung
- - I_{IEC} Strom nach IEC 947-4-3 bei Dicht-an-Dicht-Montage

last modified:

8/4/2025