







Solid-state contactor 1-phase 3RF2 AC 51 / 10 A / 40 °C 48-460 V / 24 V DC Ring cable connection

product brand name	SIRIUS
product designation	solid-state contactor
design of the product	1-pole
product type designation	3RF23
manufacturer's article number	
<ul style="list-style-type: none"> • _1 of the accessories that can be ordered • _3 of the accessories that can be ordered • _4 of the accessories that can be ordered 	3RF2900-3PA88 3RF2900-0EA18 3RF2920-0GA16
product designation	
<ul style="list-style-type: none"> • _1 of the accessories that can be ordered • _3 of the accessories that can be ordered • _4 of the accessories that can be ordered 	terminal cover converter load monitoring
General technical data	
product function	zero-point switching
power loss [W] for rated value of the current	
<ul style="list-style-type: none"> • at AC in hot operating state • at AC in hot operating state per pole • without load current share typical 	11 W 11 W 0.4 W
insulation voltage rated value	600 V
degree of pollution	3
surge voltage resistance of main circuit rated value	6 kV
protection class IP	IP00
protection class IP on the front according to IEC 60529	IP00
shock resistance according to IEC 60068-2-27	15g / 11 ms
vibration resistance according to IEC 60068-2-6	2g
reference code according to IEC 81346-2	Q
Substance Prohibitance (Date)	05/28/2009
SVHC substance name	Lead - 7439-92-1 Lead monoxide (lead oxide) - 1317-36-8 Dibutylbis(pentane-2,4-dionato-O,O')tin - 22673-19-4
Weight	0.144 kg
Main circuit	
number of poles for main current circuit	1
number of NO contacts for main contacts	1
number of NC contacts for main contacts	0
type of voltage of the operating voltage	AC
operating voltage	
<ul style="list-style-type: none"> • at AC <ul style="list-style-type: none"> — at 50 Hz rated value — at 60 Hz rated value 	48 ... 460 V 48 ... 460 V
operating frequency rated value	50 ... 60 Hz

operating range relative to the operating voltage at AC	
• at 50 Hz	40 ... 506 V
• at 60 Hz	40 ... 506 V
operational current	
• at AC-51 rated value	10.5 A
• at AC-51 according to IEC 60947-4-3	7.5 A
• according to UL 508 rated value	9.6 A
operational current minimum	100 mA
rate of voltage rise at the thyristor for main contacts maximum permissible	500 V/ μ s
blocking voltage at the thyristor for main contacts maximum permissible	1 200 V
reverse current of the thyristor	10 mA
derating temperature	40 °C
surge current resistance rated value	200 A
I²t value maximum	200 A ² ·s
Control circuit/ Control	
type of voltage of the control supply voltage	DC
control supply voltage 1 at DC rated value maximum permissible	30 V
control supply voltage 1 at DC	15 ... 24 V
control supply voltage	
• at DC initial value for signal <1> detection	15 V
• at DC full-scale value for signal<0> recognition	5 V
control current at minimum control supply voltage	
• at DC	13 mA
control current at DC rated value	15 mA
ON-delay time	1 ms; additionally max. one half-wave
OFF-delay time	1 ms; additionally max. one half-wave
Auxiliary circuit	
type of switching contact	normally open contact (NO)
number of NC contacts for auxiliary contacts	0
number of NO contacts for auxiliary contacts	0
number of CO contacts for auxiliary contacts	0
Installation/ mounting/ dimensions	
fastening method side-by-side mounting	Yes
fastening method	screw fixing and snap-on mounting on standard mounting rail 35 mm according to IEC 60715
design of the thread of the screw for securing the equipment	M4
height	95 mm
width	22.5 mm
depth	88 mm
Connections/ Terminals	
product component removable terminal for auxiliary and control circuit	Yes
type of electrical connection	
• for main current circuit	Ring cable lug connection
• for auxiliary and control circuit	ring terminal lug connection
type of connectable conductor cross-sections	
• for main contacts for JIS cable lug	JIS C 2805 R 2-5, 5,5-5, 8-5, 14-5
• for DIN cable lug for main contacts	DIN 46234 -5-2,5, -5-6, -5-10, -5-16, -5-25
type of connectable conductor cross-sections	
• for auxiliary and control contacts	
— solid	1x (0.5 ... 2.5 mm ²), 2x (0.5 ... 1 mm ²)
— finely stranded with core end processing	1x (0.5 ... 2.5 mm ²), 2x (0.5 ... 1 mm ²)
— finely stranded without core end processing	1x (0.5 ... 2.5 mm ²), 2x (0.5 ... 1 mm ²)
• for AWG cables for auxiliary and control contacts	1x (20 ... 12)
tightening torque	
• for main contacts with screw-type terminals	2 ... 2.5 N·m
• for auxiliary and control contacts with screw-type terminals	0.5 ... 0.6 N·m
tightening torque [lbf·in]	

<ul style="list-style-type: none"> for auxiliary and control contacts with screw-type terminals 	4.5 ... 5.3 lbf·in				
design of the thread of the connection screw <ul style="list-style-type: none"> for main contacts of the auxiliary and control contacts 	M5 M3				
stripped length of the cable <ul style="list-style-type: none"> for main contacts for auxiliary and control contacts 	10 mm 7 mm				
Electrical Safety					
protection class IP on the front according to IEC 60529	IP00; IP20 with cover				
touch protection on the front according to IEC 60529	finger-safe, for vertical contact from the front with cover				
Ambient conditions					
installation altitude at height above sea level maximum	1 000 m				
ambient temperature <ul style="list-style-type: none"> during operation during storage 	-25 ... +60 °C -55 ... +80 °C				
Electromagnetic compatibility					
conducted interference <ul style="list-style-type: none"> due to burst according to IEC 61000-4-4 due to conductor-earth surge according to IEC 61000-4-5 due to conductor-conductor surge according to IEC 61000-4-5 due to high-frequency radiation according to IEC 61000-4-6 	2 kV / 5 kHz behavior criterion 2 2 kV behavior criterion 2 1 kV behavior criterion 2 140 dBuV in the frequency range 0.15 ... 80 MHz, behavior criterion 1				
field-based interference according to IEC 61000-4-3	80 MHz ... 1 GHz 10 V/m, behavior criterion 1				
electrostatic discharge according to IEC 61000-4-2	4 kV contact discharging / 8 kV air discharging, behavior criterion 2				
conducted HF interference emissions according to CISPR11	Class A for industrial environment				
field-bound HF interference emission according to CISPR11	Class B for the domestic, business and commercial environments				
Short-circuit protection, design of the fuse link					
manufacturer's article number <ul style="list-style-type: none"> of gS fuse for semiconductor protection at NH design usable of full range R fuse link for semiconductor protection at cylindrical design usable of back-up R fuse link for semiconductor protection at NH design usable of back-up R fuse link for semiconductor protection at cylindrical design 10 x 38 mm usable of back-up R fuse link for semiconductor protection at cylindrical design 14 x 51 mm usable of back-up R fuse link for semiconductor protection at cylindrical design 22 x 58 mm usable 	3NE1813-0 5SE1316 3NE8015-1 3NC1016 3NC1420 3NC2220				
manufacturer's article number of the gG fuse <ul style="list-style-type: none"> at NH design usable at cylindrical design 10 x 38 mm usable at cylindrical design 14 x 51 mm usable 	3NA6801 3NW6001-1: These fuses have a smaller rated current than the semiconductor relays 3NW6101-1: These fuses have a smaller rated current than the semiconductor relays				
manufacturer's article number <ul style="list-style-type: none"> of NEOZED fuse usable 	5SE2306: These fuses have a smaller rated current than the semiconductor relays				
Approvals Certificates					
General Product Approval	EMV	Test Certificates			
 EG-Konf.		 UL		 RCM	Type Test Certificates/Test Report
other	Environment				



Further information

Information on the packaging

<https://support.industry.siemens.com/cs/ww/en/view/109813875>

Information for data generation and storage

<https://support.industry.siemens.com/cs/ww/en/view/109995012>

Information- and Downloadcenter (Catalogs, Brochures,...)

<https://www.siemens.com/ic10>

Industry Mall (Online ordering system)

<https://mall.industry.siemens.com/mall/en/en/Catalog/product?mlfb=3RF2310-3AA04>

Cax online generator

<https://support.automation.siemens.com/WW/CAXorder/default.aspx?lang=en&mlfb=3RF2310-3AA04>

Service&Support (Manuals, Certificates, Characteristics, FAQs,...)

<https://support.industry.siemens.com/cs/ww/en/ps/3RF2310-3AA04>

Image database (product images, 2D dimension drawings, 3D models, device circuit diagrams, EPLAN macros, ...)

https://www.automation.siemens.com/bilddb/cax_de.aspx?mlfb=3RF2310-3AA04&lang=en

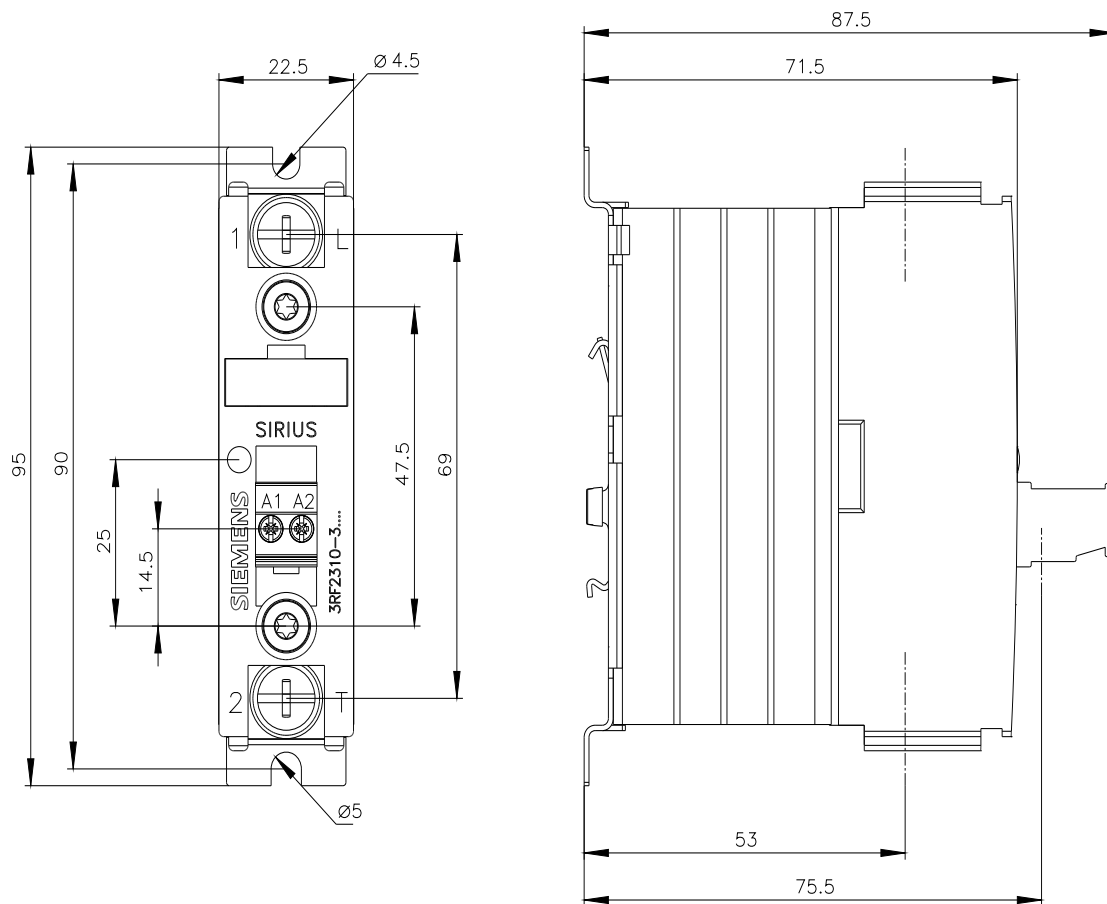

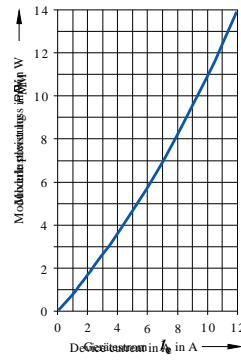
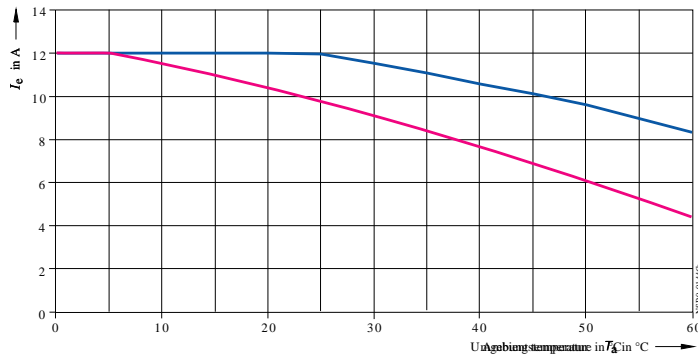

— I_{max} Thermal limit current on air-cooled DC-link
— I_{TEC} Current limit on air-cooled DC-link

last modified:

8/3/2025