







semiconductor relay, 1-phase 3RF2 width 45 mm, 20 A 48-460 V / 24 V DC screw terminal for mounting on available cooling surfaces

<b>product brand name</b>	SIRIUS
<b>product designation</b>	solid-state relay
<b>design of the product</b>	1-pole
<b>product type designation</b>	3RF20
<b>General technical data</b>	
<b>product function</b>	zero-point switching
<b>power loss [W] for rated value of the current</b>	
• at AC in hot operating state	28.6 W
• at AC in hot operating state per pole	28.6 W
• without load current share typical	0.4 W
<b>insulation voltage rated value</b>	600 V
<b>protection class IP</b>	IP20
protection class IP on the front according to IEC 60529	IP20
<b>shock resistance according to IEC 60068-2-27</b>	15g / 11 ms
<b>vibration resistance according to IEC 60068-2-6</b>	2g
<b>reference code according to IEC 81346-2</b>	Q
<b>Substance Prohibitance (Date)</b>	05/28/2009
<b>SVHC substance name</b>	Lead - 7439-92-1 Lead monoxide (lead oxide) - 1317-36-8
<b>Weight</b>	0.084 kg
<b>Main circuit</b>	
<b>number of poles for main current circuit</b>	1
<b>number of NO contacts for main contacts</b>	1
<b>number of NC contacts for main contacts</b>	0
<b>type of voltage of the operating voltage</b>	AC
<b>operating voltage</b>	
• at AC	
— at 50 Hz rated value	48 ... 460 V
— at 60 Hz rated value	48 ... 460 V
<b>operating frequency rated value</b>	50 ... 60 Hz
<b>relative symmetrical tolerance of the operating frequency</b>	10 %
<b>operating range relative to the operating voltage at AC</b>	
• at 50 Hz	40 ... 506 V
• at 60 Hz	40 ... 506 V
<b>operational current rated value maximum</b>	20 A
<b>operational current</b>	
• at AC-51 rated value	20 A
• according to UL 508 rated value	20 A
<b>operational current minimum</b>	100 mA
<b>rate of voltage rise at the thyristor for main contacts maximum permissible</b>	500 V/ $\mu$ s

<b>blocking voltage at the thyristor for main contacts maximum permissible</b>	1 200 V
<b>reverse current of the thyristor</b>	10 mA
<b>derating temperature</b>	40 °C
<b>surge current resistance rated value</b>	200 A
<b>I<sup>2</sup>t value maximum</b>	200 A <sup>2</sup> ·s
<b>Control circuit/ Control</b>	
<b>type of voltage of the control supply voltage</b>	DC
<b>control supply voltage 1 at DC rated value maximum permissible</b>	30 V
<b>control supply voltage 1 at DC</b>	15 ... 24 V
<b>control supply voltage</b>	
• at DC initial value for signal <1> detection	15 V
• at DC full-scale value for signal<0> recognition	5 V
<b>control current at minimum control supply voltage</b>	
• at DC	13 mA
control current at DC rated value	15 mA
<b>ON-delay time</b>	1 ms; additionally max. one half-wave
<b>OFF-delay time</b>	1 ms; additionally max. one half-wave
<b>Auxiliary circuit</b>	
<b>type of switching contact</b>	normally open contact (NO)
<b>number of NC contacts for auxiliary contacts</b>	0
<b>number of NO contacts for auxiliary contacts</b>	0
<b>number of CO contacts for auxiliary contacts</b>	0
<b>Installation/ mounting/ dimensions</b>	
<b>fastening method side-by-side mounting</b>	Yes
<b>fastening method</b>	screw fixing
<b>design of the thread of the screw for securing the equipment</b>	M4
<b>tightening torque of fixing screw maximum</b>	1.5 N·m
<b>tightening torque [lbf·in] of fixing screw maximum</b>	13 lbf·in
<b>height</b>	58 mm
<b>width</b>	45 mm
<b>depth</b>	48 mm
<b>Connections/ Terminals</b>	
<b>product component removable terminal for auxiliary and control circuit</b>	Yes
<b>type of electrical connection</b>	
• for main current circuit	screw-type terminals
• for auxiliary and control circuit	screw-type terminals
<b>type of connectable conductor cross-sections</b>	
• for main contacts	
— solid	2x (1.5 ... 2.5 mm <sup>2</sup> ), 2x (2.5 ... 6 mm <sup>2</sup> )
— finely stranded with core end processing	2x (1 ... 2.5 mm <sup>2</sup> ), 2x (2.5 ... 6 mm <sup>2</sup> ), 1x 10 mm <sup>2</sup>
• for AWG cables for main contacts	2x (14 ... 10)
<b>connectable conductor cross-section for main contacts</b>	
• solid or stranded	1.5 ... 6 mm <sup>2</sup>
• finely stranded with core end processing	1 ... 10 mm <sup>2</sup>
<b>type of connectable conductor cross-sections</b>	
• for auxiliary and control contacts	
— solid	1x (0.5 ... 2.5 mm <sup>2</sup> ), 2x (0.5 ... 1 mm <sup>2</sup> )
— finely stranded with core end processing	1x (0.5 ... 2.5 mm <sup>2</sup> ), 2x (0.5 ... 1 mm <sup>2</sup> )
— finely stranded without core end processing	1x (0.5 ... 2.5 mm <sup>2</sup> ), 2x (0.5 ... 1 mm <sup>2</sup> )
• for AWG cables for auxiliary and control contacts	1x (20 ... 12)
<b>AWG number as coded connectable conductor cross section for main contacts</b>	14 ... 10
<b>tightening torque</b>	
• for main contacts with screw-type terminals	2 ... 2.5 N·m
• for auxiliary and control contacts with screw-type terminals	0.5 ... 0.6 N·m
<b>tightening torque [lbf·in]</b>	
• for main contacts with screw-type terminals	7 ... 10.3 lbf·in

<ul style="list-style-type: none"> <li>for auxiliary and control contacts with screw-type terminals</li> </ul>	4.5 ... 5.3 lbf·in
<b>design of the thread of the connection screw</b>	
<ul style="list-style-type: none"> <li>for main contacts</li> <li>of the auxiliary and control contacts</li> </ul>	M4 M3
<b>stripped length of the cable</b>	
<ul style="list-style-type: none"> <li>for main contacts</li> <li>for auxiliary and control contacts</li> </ul>	10 mm 7 mm
<b>Electrical Safety</b>	
<b>protection class IP on the front according to IEC 60529</b>	IP20
<b>touch protection on the front according to IEC 60529</b>	finger-safe, for vertical contact from the front
<b>Ambient conditions</b>	
installation altitude at height above sea level maximum	1 000 m
<b>ambient temperature</b>	
<ul style="list-style-type: none"> <li>during operation</li> <li>during storage</li> </ul>	-25 ... +60 °C -55 ... +80 °C
<b>Electromagnetic compatibility</b>	
<b>conducted interference</b>	
<ul style="list-style-type: none"> <li>due to burst according to IEC 61000-4-4</li> <li>due to conductor-earth surge according to IEC 61000-4-5</li> <li>due to conductor-conductor surge according to IEC 61000-4-5</li> <li>due to high-frequency radiation according to IEC 61000-4-6</li> </ul>	2 kV / 5 kHz behavior criterion 2 2 kV behavior criterion 2 1 kV behavior criterion 2 140 dBuV in the frequency range 0.15 ... 80 MHz, behavior criterion 1
<b>field-based interference according to IEC 61000-4-3</b>	80 MHz ... 1 GHz 10 V/m, behavior criterion 1
<b>electrostatic discharge according to IEC 61000-4-2</b>	4 kV contact discharging / 8 kV air discharging, behavior criterion 2
<b>conducted HF interference emissions according to CISPR11</b>	Class A for industrial environment
<b>field-bound HF interference emission according to CISPR11</b>	Class B for the domestic, business and commercial environments
<b>Short-circuit protection, design of the fuse link</b>	
<p>manufacturer's article number</p> <ul style="list-style-type: none"> <li>of gS fuse for semiconductor protection at NH design usable</li> <li>of full range R fuse link for semiconductor protection at cylindrical design usable</li> <li>of back-up R fuse link for semiconductor protection at NH design usable</li> <li>of back-up R fuse link for semiconductor protection at cylindrical design 10 x 38 mm usable</li> <li>of back-up R fuse link for semiconductor protection at cylindrical design 14 x 51 mm usable</li> <li>of back-up R fuse link for semiconductor protection at cylindrical design 22 x 58 mm usable</li> </ul>	<a href="#">3NE1813-0: These fuses have a smaller rated current than the semiconductor relays</a> <a href="#">5SE1320</a> <a href="#">3NE8015-1</a> <a href="#">3NC1016: These fuses have a smaller rated current than the semiconductor relays</a> <a href="#">3NC1425</a> <a href="#">3NC2220</a>
<p>manufacturer's article number of the gG fuse</p> <ul style="list-style-type: none"> <li>at NH design usable</li> <li>at cylindrical design 14 x 51 mm usable</li> </ul>	<a href="#">3NA6801: These fuses have a smaller rated current than the semiconductor relays</a> <a href="#">3NW6101-1: These fuses have a smaller rated current than the semiconductor relays</a>
<p>manufacturer's article number</p> <ul style="list-style-type: none"> <li>of NEOZED fuse usable</li> </ul>	<a href="#">5SE2306: These fuses have a smaller rated current than the semiconductor relays</a>
<b>Approvals Certificates</b>	
<b>General Product Approval</b>	<b>Test Certificates</b>
    	<a href="#">Type Test Certificates/Test Report</a>
<b>other</b>	<b>Environment</b>



[Confirmation](#)

[Environmental Confirmations](#)

Further information

Information on the packaging

<https://support.industry.siemens.com/cs/ww/en/view/109813875>

Information for data generation and storage

<https://support.industry.siemens.com/cs/ww/en/view/109995012>

Information- and Downloadcenter (Catalogs, Brochures,...)

<https://www.siemens.com/ic10>

Industry Mall (Online ordering system)

<https://mall.industry.siemens.com/mall/en/en/Catalog/product?mlfb=3RF2020-1AA04>

Cax online generator

<http://support.automation.siemens.com/WW/CAXorder/default.aspx?lang=en&mlfb=3RF2020-1AA04>

Service&Support (Manuals, Certificates, Characteristics, FAQs,...)

<https://support.industry.siemens.com/cs/ww/en/ps/3RF2020-1AA04>

Image database (product images, 2D dimension drawings, 3D models, device circuit diagrams, EPLAN macros, ...)

[http://www.automation.siemens.com/bilddb/cax\\_de.aspx?mlfb=3RF2020-1AA04&lang=en](http://www.automation.siemens.com/bilddb/cax_de.aspx?mlfb=3RF2020-1AA04&lang=en)

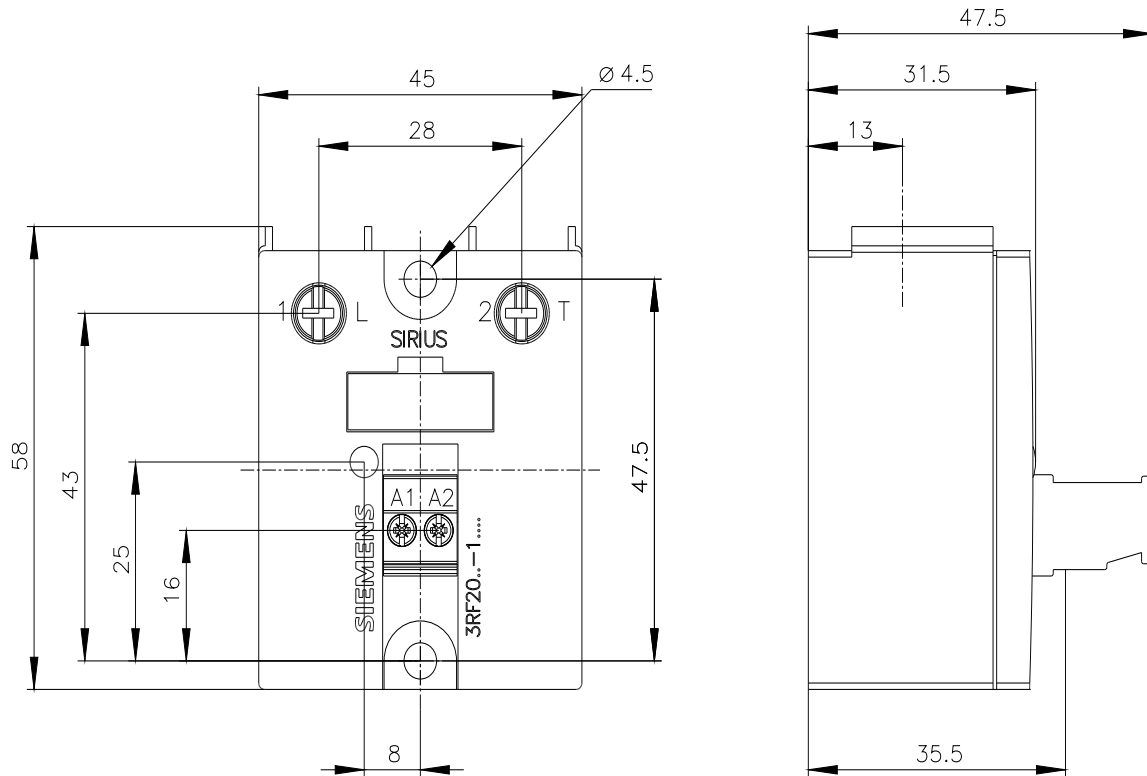

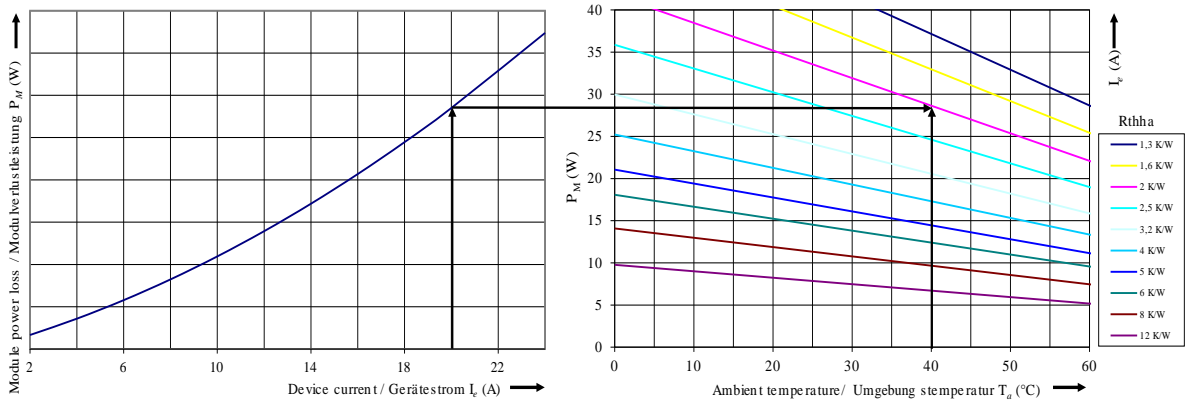

last modified:

8/4/2025