







intelligent load feeder direct starter high feature 0.4-4 A up to 690 V AC type of coordination 2 frame size S00 for ET 200SP system consisting of 3RC7140-1EE10, 3RV2311-1EC20, 3RT2017-2BB42

| | |
|--|---|
| product brand name | SIRIUS |
| product designation | Intelligent load feeder |
| design of the product | High Feature direct starter |
| product type designation | 3RA8 |
| manufacturer's article number | |
| <ul style="list-style-type: none"> of the supplied contactor of the supplied circuit-breakers of the supplied link module | 3RT2017-2BB42 3RV2311-1EC20 3RC7140-1EE10 |
| General technical data | |
| number of monitored phases | 3 |
| suitability for use | |
| <ul style="list-style-type: none"> direct starter reversing starter star-delta starter | Yes No No |
| product function external reset | Yes |
| product component RESET button | Yes |
| design of the overcurrent release | electronic |
| size of the circuit-breaker | S00 |
| size of load feeder | S00 |
| size of contactor can be combined company-specific | S00 |
| product function | |
| <ul style="list-style-type: none"> remote firmware update disconnecter functionality for power supply reverse polarity protection | Yes Yes Yes |
| power loss [W] for rated value of the current at AC in hot operating state per pole | 2.6 W |
| insulation voltage | |
| <ul style="list-style-type: none"> rated value for overvoltage category III according to IEC 60664 with degree of pollution 2 rated value | 690 V 690 V |
| degree of pollution | 3 |
| overvoltage category | 3 |
| surge voltage resistance rated value | 6 kV |
| protection class IP | |
| <ul style="list-style-type: none"> on the front of the terminal | IP20 IP20 |
| shock resistance according to IEC 60068-2-27 | 6g / 11,0 ms (3 shocks); 10g / 6,0 ms (1000 shocks) |
| vibration resistance | 5-8,4 Hz, 3,5 mm; 8,4-150 Hz, 1 g; 10 cycles / 10-60 Hz, 0,35 mm; 60-500 Hz, 5 g; 10 cycles |
| type of coordination | 2 |
| reference code according to IEC 81346-2 | Q |

| | |
|---|--|
| reference code according to IEC 81346-2:2019 | Q |
| continuous current rated value | 4 A |
| Substance Prohibitance (Date) | 06/21/2024 |
| SVHC substance name | Lead - 7439-92-1 Lead monoxide (lead oxide) - 1317-36-8 Silicic acid, lead salt - 11120-22-2 2,2',6,6'-tetrabromo-4,4'-isopropylidenediphenol - 79-94-7 |
| Weight | 1.066 kg |
| Ambient conditions | |
| installation altitude at height above sea level maximum | 2 000 m |
| ambient temperature | |
| • during operation | -20 ... +60 °C |
| • during storage | -40 ... +80 °C |
| • during transport | -40 ... +80 °C |
| • with upper limit without restrictions | 40 °C |
| environmental category during operation according to IEC 60721 | 3C3 (without salt spray) |
| relative humidity during operation | 10 ... 95 % |
| Main circuit | |
| number of poles for main current circuit | 3 |
| design of the switching contact | electromechanical |
| adjustable current response value current of the current-dependent overload release | 0.4 ... 4 A |
| type of the motor protection | solid-state |
| type of voltage for main current circuit | AC |
| utilization category according to IEC 60947-4-1 | AC-3e |
| operating voltage | |
| • rated value | 690 V |
| • at AC-3 rated value maximum | 690 V |
| • at AC-3e rated value maximum | 690 V |
| operating frequency rated value | 50 ... 60 Hz |
| operational current rated value | 4 A |
| operational current | |
| • at AC-3 | |
| — at 400 V rated value | 4 A |
| — at 440 V rated value | 4 A |
| — at 500 V rated value | 4 A |
| — at 690 V rated value | 4 A |
| • at AC-3e | |
| — at 400 V rated value | 4 A |
| — at 440 V rated value | 4 A |
| — at 500 V rated value | 4 A |
| — at 690 V rated value | 4 A |
| operating power | |
| • at AC-3 | |
| — at 400 V rated value | 1 500 W |
| — at 500 V rated value | 2 200 W |
| — at 690 V rated value | 3 000 W |
| • at AC-3e | |
| — at 400 V rated value | 1 500 W |
| — at 500 V rated value | 2 200 W |
| — at 690 V rated value | 3 000 W |
| Control circuit/ Control | |
| type of voltage of the control supply voltage | DC |
| closing delay at DC | 40 ... 110 ms |
| opening delay at DC | 30 ... 50 ms |
| Auxiliary circuit | |
| product component auxiliary switch | No |
| product extension auxiliary switch | Yes |
| type of voltage for auxiliary and control circuit | DC |
| auxiliary voltage at DC rated value | 24 V |
| auxiliary voltage at DC rated value | 20.4 ... 28.8 V |

| | |
|--|--|
| inrush current peak for auxiliary voltage at DC at 24 V | 2.5 A |
| duration of inrush current peak for auxiliary voltage at DC at 24 V | 1 ms |
| power loss [W] at the auxiliary voltage in holding operation at DC at 24 V | 0.9 W |
| Protective and monitoring functions | |
| type of protection function of the overcurrent release | electronic |
| product function | |
| <ul style="list-style-type: none"> ● ground fault detection ● phase failure detection ● phase sequence recognition ● overcurrent detection 1 phase ● undercurrent detection 3 phases ● undercurrent monitoring ● overcurrent and undercurrent monitoring ● undercurrent detection 1 phase ● overcurrent detection 3 phase ● overload protection ● overload warning ● temperature-compensated overload protection ● motor protection ● active current monitoring ● main switches with supply disconnect function and EM-STOP switches ● operating hours counter | <ul style="list-style-type: none"> No Yes Yes Yes Yes Yes Yes Yes Yes Yes Yes No Yes No No Yes |
| trip class | CLASS 10E / CLASS 20E |
| design of the overload release | electronic |
| response value current of instantaneous short-circuit trip unit | 52 A |
| UL/CSA ratings | |
| full-load current (FLA) for 3-phase AC motor | |
| <ul style="list-style-type: none"> ● at 480 V rated value ● at 600 V rated value | <ul style="list-style-type: none"> 4 A 4 A |
| yielded mechanical performance [hp] | |
| <ul style="list-style-type: none"> ● for single-phase AC motor <ul style="list-style-type: none"> — at 110/120 V rated value — at 230 V rated value ● for 3-phase AC motor <ul style="list-style-type: none"> — at 200/208 V rated value — at 220/230 V rated value — at 460/480 V rated value — at 575/600 V rated value | <ul style="list-style-type: none"> 0.16 hp 0.5 hp 1 hp 1 hp 3 hp 3 hp |
| conditional short-circuit current (I_q) with type of coordination 1 | |
| <ul style="list-style-type: none"> ● at 480 AC Y/277 V rated value | 65 000 A |
| operating voltage | |
| <ul style="list-style-type: none"> ● according to UL 60947 rated value ● at AC at 60 Hz according to CSA and UL rated value | <ul style="list-style-type: none"> 600 V 600 V |
| Short-circuit protection | |
| product function short circuit protection | Yes |
| design of the short-circuit trip | magnetic |
| conditional short-circuit current (I_q) | |
| <ul style="list-style-type: none"> ● at 690 V according to IEC 60947-4-1 rated value ● at 400 V according to IEC 60947-4-1 rated value ● at 440 V according to IEC 60947-4-1 rated value ● at 500 V according to IEC 60947-4-1 rated value | <ul style="list-style-type: none"> 1 000 A 150 000 A 100 000 A 10 000 A |
| conditional short-circuit current (I_q) with type of coordination 2 | |
| <ul style="list-style-type: none"> ● at 230 V rated value ● at 400 V rated value | <ul style="list-style-type: none"> 150 000 A 150 000 A |
| certificate of suitability ATEX | No |
| Installation/ mounting/ dimensions | |
| mounting position | vertical, on horizontal standard mounting rail |

| | |
|--|--|
| fastening method | screw and snap-on mounting onto 35 mm DIN rail |
| • mounting rail | Yes |
| height | 198 mm |
| width | 45 mm |
| depth | 131 mm |
| required spacing | |
| • for grounded parts at 400 V | |
| — downwards | 10 mm |
| — upwards | 20 mm |
| — backwards | 0 mm |
| — at the side | 9 mm |
| — forwards | 0 mm |
| • for live parts at 400 V | |
| — downwards | 10 mm |
| — upwards | 20 mm |
| — backwards | 0 mm |
| — at the side | 9 mm |
| — forwards | 0 mm |
| • for grounded parts at 500 V | |
| — downwards | 10 mm |
| — upwards | 20 mm |
| — backwards | 0 mm |
| — at the side | 9 mm |
| — forwards | 0 mm |
| • for live parts at 500 V | |
| — downwards | 10 mm |
| — upwards | 20 mm |
| — backwards | 0 mm |
| — at the side | 9 mm |
| — forwards | 0 mm |
| • for grounded parts at 690 V | |
| — downwards | 10 mm |
| — upwards | 50 mm |
| — at the side | 20 mm |
| — forwards | 0 mm |
| • for live parts at 690 V | |
| — downwards | 10 mm |
| — upwards | 50 mm |
| — at the side | 20 mm |
| — forwards | 0 mm |
| Connections/ Terminals | |
| product component removable terminal for auxiliary and control circuit | No |
| type of electrical connection | |
| • for main current circuit | spring-loaded terminals |
| • for auxiliary and control circuit | spring-loaded terminals (push-in) |
| type of electrical connection for supply voltage line-side | spring-loaded terminals (push-in) |
| type of connectable conductor cross-sections | |
| • for main contacts | |
| — solid | 2x (0.5 ... 4 mm ²) |
| — stranded | 2x (0.5 ... 4 mm ²) |
| — finely stranded with core end processing | 2x (0.5 ... 2.5 mm ²) |
| • for AWG cables for main contacts | 2x 20 ... 12 |
| connectable conductor cross-section for main contacts | |
| • solid | 0.5 ... 4 mm ² |
| • stranded | 0.5 ... 4 mm ² |
| • finely stranded with core end processing | 0.5 ... 2.5 mm ² |
| type of connectable conductor cross-sections at the inputs for supply voltage | |
| • solid | 0.2 ... 1.5 mm ² |
| • finely stranded without core end processing | 0.2 ... 1.5 mm ² |

| | | | |
|---|---|---|--|
| <ul style="list-style-type: none"> finely stranded with core end processing | 0.2 ... 1.0 mm ² | | |
| type of connectable conductor cross-sections at the inputs for supply voltage for AWG cables solid | 24 ... 16 | | |
| Electrical Safety | | | |
| touch protection against electrical shock | IP20 | | |
| touch protection on the front according to IEC 60529 | finger-safe | | |
| Communication/ Protocol | | | |
| protocol is supported other protocols | Yes | | |
| product function bus communication | Yes | | |
| product function control circuit interface with IO link | No | | |
| product function control circuit interface with AS-interface | No | | |
| data volume | | | |
| <ul style="list-style-type: none"> of the address range of the inputs with cyclical transfer total | 16 byte | | |
| <ul style="list-style-type: none"> of the address range of the outputs with cyclical transfer total | 2 byte | | |
| address space memory of address range | | | |
| <ul style="list-style-type: none"> of the inputs | 16 byte | | |
| <ul style="list-style-type: none"> of the outputs | 2 byte | | |
| type of electrical connection of the communication interface | RJ45 | | |
| Electromagnetic compatibility | | | |
| conducted interference | | | |
| <ul style="list-style-type: none"> due to burst according to IEC 61000-4-4 | 2 kV | | |
| <ul style="list-style-type: none"> due to conductor-earth surge according to IEC 61000-4-5 | 2 kV | | |
| <ul style="list-style-type: none"> due to conductor-conductor surge according to IEC 61000-4-5 | 1 kV | | |
| <ul style="list-style-type: none"> due to high-frequency radiation according to IEC 61000-4-6 | 10 V | | |
| field-based interference according to IEC 61000-4-3 | 10 V/m | | |
| electrostatic discharge according to IEC 61000-4-2 | 8 kV air discharge | | |
| conducted HF interference emissions according to CISPR11 | Class A for industrial environment | | |
| field-bound HF interference emission according to CISPR11 | Class A for industrial environment | | |
| Supply voltage | | | |
| type of voltage of the supply voltage | DC | | |
| supply voltage 1 at DC rated value | | | |
| <ul style="list-style-type: none"> minimum permissible | 19.2 V | | |
| <ul style="list-style-type: none"> maximum permissible | 28.8 V | | |
| auxiliary voltage at DC rated value | 20.4 ... 28.8 V | | |
| supply voltage at DC rated value | 24 V | | |
| inrush current peak with supply voltage at DC at 24 V | 1.25 A | | |
| duration of inrush current peak with supply voltage at DC at 24 V | 5 ms | | |
| power loss [W] at supply voltage at DC at 24 V | 0.5 W | | |
| Approvals Certificates | | | |
| General Product Approval | EMV | Test Certificates | other |
|  EG-Konf. |  |  UL |  RCM |
| | | Type Test Certificates/Test Report | Confirmation |
| other | Environment | | |
|  | Environmental Conformations | | |
| Further information | | | |
| Information on the packaging https://support.industry.siemens.com/cs/ww/en/view/109813875 | | | |
| Information for data generation and storage | | | |

<https://support.industry.siemens.com/cs/ww/en/view/109995012>

Information- and Downloadcenter (Catalogs, Brochures,...)

<https://www.siemens.com/ic10>

Industry Mall (Online ordering system)

<https://mall.industry.siemens.com/mall/en/en/Catalog/product?mlfb=3RA8412-1EE10>

Cax online generator

<https://support.automation.siemens.com/WW/CAxorder/default.aspx?lang=en&mlfb=3RA8412-1EE10>

Service&Support (Manuals, Certificates, Characteristics, FAQs,...)

<https://support.industry.siemens.com/cs/ww/en/ps/3RA8412-1EE10>

Image database (product images, 2D dimension drawings, 3D models, device circuit diagrams, EPLAN macros, ...)

https://www.automation.siemens.com/bilddb/cax_de.aspx?mlfb=3RA8412-1EE10&lang=en

Characteristic: Tripping characteristics, I²t, Let-through current

<https://support.industry.siemens.com/cs/ww/en/ps/3RA8412-1EE10/char>

Further characteristics (e.g. electrical endurance, switching frequency)

<https://www.automation.siemens.com/bilddb/index.aspx?view=Search&mlfb=3RA8412-1EE10&objecttype=14&gridview=view1>

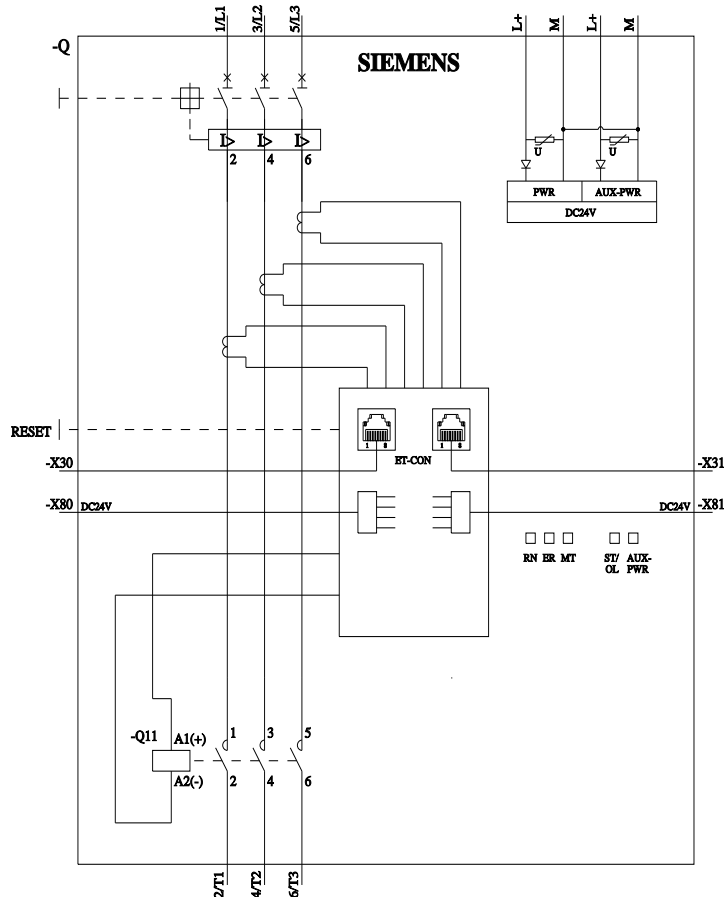
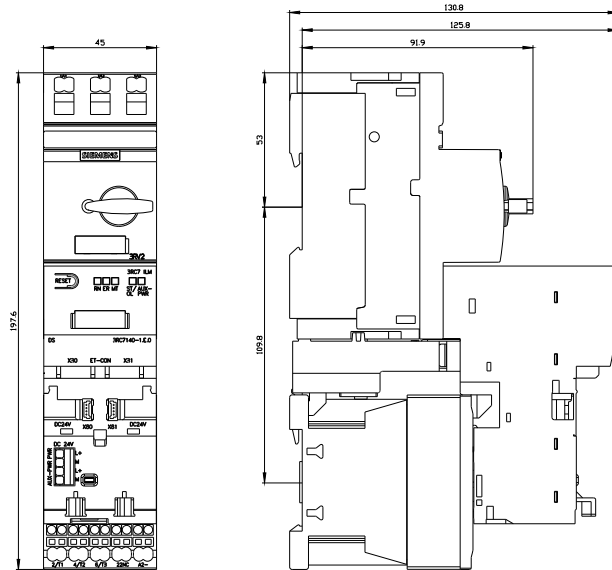

last modified:

8/14/2025

