

Contactor assembly for star-delta (wye-delta) start AC-3, 75 kW/400 V 110 V AC, 50/60 Hz Size S3, screw terminal electrical and mechanical interlock 3 NO+3 NC



<b>product brand name</b>	SIRIUS
<b>product designation</b>	Contactor assembly for star-delta (wye-delta) start
<b>product type designation</b>	3RA24
<b>manufacturer's article number</b>	
<ul style="list-style-type: none"> <li>• 1 of the supplied contactor</li> <li>• 2 of the supplied contactor</li> <li>• 3 of the supplied contactor</li> <li>• of the supplied RS assembly kit</li> <li>• of the supplied function module for wye-delta circuits</li> </ul>	<a href="#">3RT2045-1AG20</a> <a href="#">3RT2045-1AG20</a> <a href="#">3RT2036-1AG20</a> <a href="#">3RA2943-2C</a> <a href="#">3RA2816-0EW20</a>
<b>General technical data</b>	
<b>size of contactor</b>	S3
product extension auxiliary switch	No
<b>shock resistance at rectangular impulse</b>	
<ul style="list-style-type: none"> <li>• at AC</li> </ul>	6.7 g / 5 ms, 4.0 g / 10 ms
<b>shock resistance with sine pulse</b>	
<ul style="list-style-type: none"> <li>• at AC</li> </ul>	10.6 g / 5 ms, 6.3 g / 10 ms
<b>mechanical service life (operating cycles)</b>	
<ul style="list-style-type: none"> <li>• of contactor typical</li> <li>• of the contactor with added auxiliary switch block typical</li> </ul>	10 000 000 10 000 000
<b>reference code according to IEC 81346-2</b>	Q
<b>Substance Prohibittance (Date)</b>	03/01/2017
<b>SVHC substance name</b>	Lead - 7439-92-1 Lead monoxide (lead oxide) - 1317-36-8 6,6'-di-tert-butyl-2,2'-methylenedi-p-cresol - 119-47-1
<b>Weight</b>	5.44 kg
<b>Ambient conditions</b>	
installation altitude at height above sea level maximum	2 000 m
<b>ambient temperature</b>	
<ul style="list-style-type: none"> <li>• during operation</li> <li>• during storage</li> </ul>	-25 ... +60 °C -55 ... +80 °C
<b>Main circuit</b>	
<b>number of poles for main current circuit</b>	3
<b>number of NO contacts for main contacts</b>	3
<b>number of NC contacts for main contacts</b>	0
<b>operating voltage</b>	
<ul style="list-style-type: none"> <li>• at AC-3 rated value maximum</li> </ul>	690 V
<b>operational current</b>	
<ul style="list-style-type: none"> <li>• at AC-3</li> <li>— at 400 V rated value</li> </ul>	150 A
<b>operating power</b>	
<ul style="list-style-type: none"> <li>• at AC-3</li> </ul>	

— at 400 V rated value	75 kW
— at 690 V rated value	110 kW
<b>operating frequency</b>	
• at AC-3 maximum	1 000 1/h
<b>Control circuit/ Control</b>	
<b>type of voltage of the control supply voltage</b>	AC
<b>control supply voltage 1 at AC</b>	
• at 50 Hz rated value	110 V
• at 60 Hz rated value	110 V
<b>operating range factor control supply voltage rated value of magnet coil at AC</b>	
• at 50 Hz	0.8 ... 1.1
• at 60 Hz	0.85 ... 1.1
<b>apparent pick-up power of magnet coil at AC</b>	
• at 50 Hz	698 VA
• at 60 Hz	594 VA
<b>inductive power factor with closing power of the coil</b>	
• at 50 Hz	0.62
• at 60 Hz	0.55
<b>apparent holding power of magnet coil at AC</b>	
• at 50 Hz	52 VA
• at 60 Hz	38 VA
<b>inductive power factor with the holding power of the coil</b>	
• at 50 Hz	0.35
• at 60 Hz	0.41
<b>Auxiliary circuit</b>	
<b>number of NC contacts for auxiliary contacts</b>	
• instantaneous contact	3
number of NO contacts for auxiliary contacts	
• instantaneous contact	3
<b>UL/CSA ratings</b>	
<b>contact rating of auxiliary contacts according to UL</b>	A600 / Q600
<b>Short-circuit protection</b>	
<b>design of the fuse link</b>	
• for short-circuit protection of the main circuit	
— with type of coordination 1 required	gG NH 3NA, DIAZED 5SB, NEOZED 5SE: 250 A
— with type of coordination 2 required	gG NH 3NA, DIAZED 5SB, NEOZED 5SE: 160 A
• for short-circuit protection of the auxiliary switch required	fuse gG: 10 A
<b>Installation/ mounting/ dimensions</b>	
<b>mounting position</b>	+/-180° rotation possible on vertical mounting surface; can be tilted forward and backward by +/- 22.5° on vertical mounting surface
<b>fastening method</b>	screw and snap-on mounting onto 35 mm DIN rail
<b>height</b>	180 mm
<b>width</b>	220 mm
<b>depth</b>	244 mm
<b>required spacing</b>	
• with side-by-side mounting	
— forwards	10 mm
— backwards	0 mm
— upwards	10 mm
— downwards	10 mm
— at the side	10 mm
• for grounded parts	
— forwards	10 mm
— backwards	0 mm
— upwards	10 mm
— at the side	10 mm
— downwards	10 mm
• for live parts	
— forwards	10 mm
— backwards	0 mm

— upwards	10 mm
— downwards	10 mm
— at the side	10 mm

#### Connections/ Terminals

<b>type of electrical connection</b>	
<ul style="list-style-type: none"> <li>• for main current circuit</li> <li>• for auxiliary and control circuit</li> <li>• at contactor for auxiliary contacts</li> <li>• of magnet coil</li> </ul>	screw-type terminals screw-type terminals Screw-type terminals Screw-type terminals
<b>type of connectable conductor cross-sections for main contacts</b>	
<ul style="list-style-type: none"> <li>• solid or stranded</li> <li>• finely stranded with core end processing</li> <li>• finely stranded without core end processing</li> </ul>	2x (2.5 ... 16 mm <sup>2</sup> ), 2x (10 ... 50 mm <sup>2</sup> ), 1x (10 ... 70 mm <sup>2</sup> ) 2x (2.5 ... 35 mm <sup>2</sup> ), 1x (2.5 ... 50 mm <sup>2</sup> ) 2x (10 ... 35 mm <sup>2</sup> ), 1x (10 ... 50 mm <sup>2</sup> )
<b>type of connectable conductor cross-sections</b>	
<ul style="list-style-type: none"> <li>• for auxiliary contacts               <ul style="list-style-type: none"> <li>— solid or stranded</li> <li>— finely stranded with core end processing</li> </ul> </li> <li>• for AWG cables for auxiliary contacts</li> </ul>	2x (0.5 ... 1.5 mm <sup>2</sup> ), 2x (0.75 ... 2.5 mm <sup>2</sup> ) 2x (0.5 ... 1.5 mm <sup>2</sup> ), 2x (0.75 ... 2.5 mm <sup>2</sup> ) 2x (20 ... 16), 2x (18 ... 14)





#### Safety related data

product function suitable for safety function	Yes
<b>Electrical Safety</b>	
<b>protection class IP on the front according to IEC 60529</b>	IP20
<b>touch protection on the front according to IEC 60529</b>	finger-safe, for vertical contact from the front

#### Communication/ Protocol

<b>product function bus communication</b>	No
protocol is supported AS-Interface protocol	No
product function control circuit interface with IO link	No

#### Approvals Certificates

<b>General Product Approval</b>	<b>other</b>	<b>Dangerous goods</b>
	 EG-Konf.	
	<a href="#">Confirmation</a>	
		<a href="#">Transport Information</a>

#### Environment

[Environmental Conformations](#)

#### Further information

**Information on the packaging**  
<https://support.industry.siemens.com/cs/ww/en/view/109813875>

**Information for data generation and storage**  
<https://support.industry.siemens.com/cs/ww/en/view/109995012>

**Information- and Downloadcenter (Catalogs, Brochures,...)**  
<https://www.siemens.com/ic10>

**Industry Mall (Online ordering system)**  
<https://mall.industry.siemens.com/mall/en/en/Catalog/product?mlfb=3RA2445-8XF32-1AG2>

**Cax online generator**  
<https://support.automation.siemens.com/WW/CAXorder/default.aspx?lang=en&mlfb=3RA2445-8XF32-1AG2>

**Service&Support (Manuals, Certificates, Characteristics, FAQs,...)**  
<https://support.industry.siemens.com/cs/ww/en/ps/3RA2445-8XF32-1AG2>

**Image database (product images, 2D dimension drawings, 3D models, device circuit diagrams, EPLAN macros, ...)**  
[https://www.automation.siemens.com/bilddb/cax\\_de.aspx?mlfb=3RA2445-8XF32-1AG2&lang=en](https://www.automation.siemens.com/bilddb/cax_de.aspx?mlfb=3RA2445-8XF32-1AG2&lang=en)

**Characteristic: Tripping characteristics, I<sup>2</sup>t, Let-through current**  
<https://support.industry.siemens.com/cs/ww/en/ps/3RA2445-8XF32-1AG2/char>

**Further characteristics (e.g. electrical endurance, switching frequency)**  
<https://www.automation.siemens.com/bilddb/index.aspx?view=Search&mlfb=3RA2445-8XF32-1AG2&objecttype=14&gridview=view1>

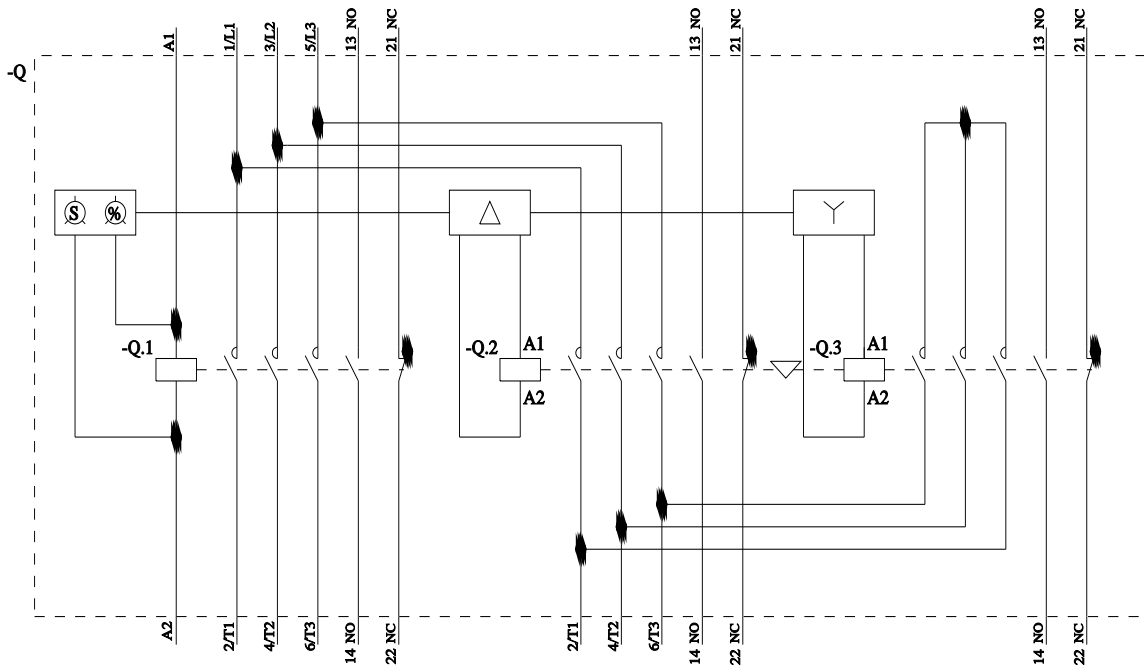
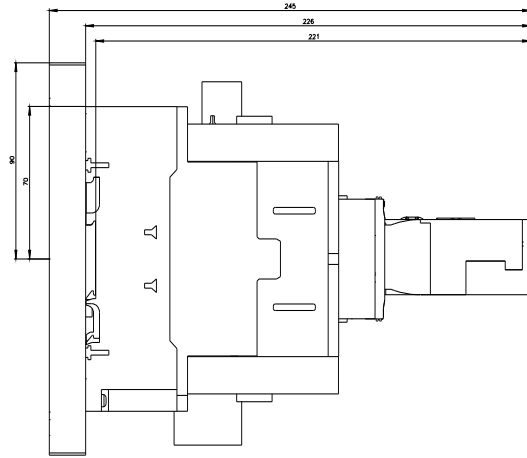
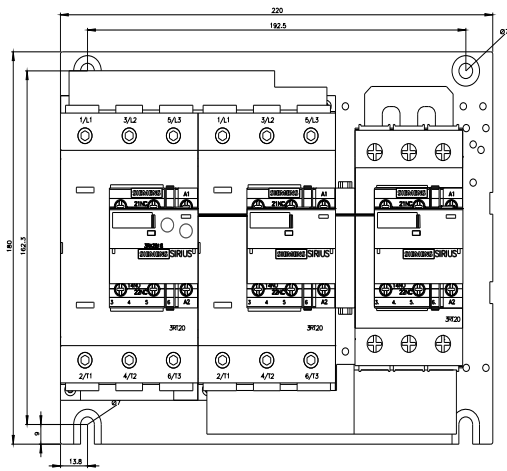

last modified:

6/29/2025

