

reversing contactor assembly, AC-3e/AC-3, 16 A, 7.5 kW / 400 V, 3-pole, 24 V AC, 50/60 Hz, screw terminal, electrical and mechanical interlock



product brand name	SIRIUS
product designation	Reversing contactor assembly
product type designation	3RA23
manufacturer's article number	
<ul style="list-style-type: none"> • 1 of the supplied contactor • 2 of the supplied contactor • of the supplied RH assembly kit 	3RT2018-1AB02 3RT2018-1AB02 3RA2913-2AA1
General technical data	
size of contactor	S00
product extension auxiliary switch	Yes
shock resistance at rectangular impulse	
<ul style="list-style-type: none"> • at AC • at DC 	7,3g / 5 ms, 4,7g / 10 ms 7,3g / 5 ms, 4,7g / 10 ms
shock resistance with sine pulse	
<ul style="list-style-type: none"> • at AC • at DC 	11,4g / 5 ms, 7,3g / 10 ms 11,4g / 5 ms, 7,3g / 10 ms
mechanical service life (operating cycles)	
<ul style="list-style-type: none"> • of contactor typical • of the contactor with added auxiliary switch block typical 	10 000 000 10 000 000
reference code according to IEC 81346-2	Q
Substance Prohibition (Date)	10/01/2009
Weight	0.483 kg
Ambient conditions	
installation altitude at height above sea level maximum	2 000 m
ambient temperature	
<ul style="list-style-type: none"> • during operation • during storage 	-25 ... +60 °C -55 ... +80 °C
Main circuit	
number of poles for main current circuit	3
number of NO contacts for main contacts	3
number of NC contacts for main contacts	0
operating voltage	
<ul style="list-style-type: none"> • at AC-3 rated value maximum • at AC-3e rated value maximum 	690 V 690 V
operational current	
<ul style="list-style-type: none"> • at AC-3 <ul style="list-style-type: none"> — at 400 V rated value — at 500 V rated value — at 690 V rated value • at AC-3e 	16 A 12.4 A 8.9 A

— at 400 V rated value	16 A
— at 500 V rated value	12.4 A
— at 690 V rated value	8.9 A
operating power	
● at AC-3	
— at 400 V rated value	7.5 kW
— at 500 V rated value	7.5 kW
— at 690 V rated value	7.5 kW
● at AC-3e	
— at 400 V rated value	7.5 kW
— at 690 V rated value	7.5 kW
● at AC-4 at 400 V rated value	5.5 kW
operating frequency	
● at AC-3 maximum	750 1/h
● at AC-3e maximum	750 1/h
Control circuit/ Control	
type of voltage of the control supply voltage	AC
control supply voltage 1 at AC	
● at 50 Hz rated value	24 V
● at 60 Hz rated value	24 V
operating range factor control supply voltage rated value of magnet coil at AC	
● at 50 Hz	0.8 ... 1.1
● at 60 Hz	0.85 ... 1.1
apparent pick-up power of magnet coil at AC	
● at 50 Hz	37 VA
inductive power factor with closing power of the coil	
● at 50 Hz	0.8
apparent holding power of magnet coil at AC	
● at 50 Hz	5.7 VA
inductive power factor with the holding power of the coil	
● at 50 Hz	0.28
Auxiliary circuit	
contact reliability of auxiliary contacts	< 1 error per 100 million operating cycles
UL/CSA ratings	
full-load current (FLA) for 3-phase AC motor	
● at 480 V rated value	14 A
● at 600 V rated value	11 A
yielded mechanical performance [hp] for 3-phase AC motor	
● at 200/208 V rated value	3 hp
● at 220/230 V rated value	5 hp
● at 460/480 V rated value	10 hp
● at 575/600 V rated value	10 hp
contact rating of auxiliary contacts according to UL	A600 / Q600
Short-circuit protection	
design of the fuse link	
● for short-circuit protection of the main circuit	
— with type of coordination 1 required	gG NH 3NA, DIAZED 5SB, NEOZED 5SE: 50 A
— with type of coordination 2 required	gG NH 3NA, DIAZED 5SB, NEOZED 5SE: 25 A
● for short-circuit protection of the auxiliary switch required	fuse gG: 10 A
Installation/ mounting/ dimensions	
mounting position	+/-180° rotation possible on vertical mounting surface; can be tilted forward and backward by +/- 22.5° on vertical mounting surface
fastening method	screw and snap-on mounting onto 35 mm DIN rail
height	68 mm
width	90 mm
depth	73 mm
required spacing	
● with side-by-side mounting	
— forwards	6 mm
— backwards	0 mm

— upwards	6 mm
— downwards	6 mm
— at the side	6 mm
• for grounded parts	
— forwards	6 mm
— backwards	0 mm
— upwards	6 mm
— at the side	6 mm
— downwards	6 mm
• for live parts	
— forwards	6 mm
— backwards	0 mm
— upwards	6 mm
— downwards	6 mm
— at the side	6 mm

Connections/ Terminals

type of electrical connection	
• for main current circuit	screw-type terminals
• for auxiliary and control circuit	screw-type terminals
• at contactor for auxiliary contacts	Screw-type terminals
• of magnet coil	Screw-type terminals
type of connectable conductor cross-sections for main contacts	
• solid	2x (0.5 ... 1.5 mm ²), 2x (0.75 ... 2.5 mm ²), 2x 4 mm ²
• solid or stranded	2x (0,5 ... 1,5 mm ²), 2x (0,75 ... 2,5 mm ²), 2x (0,5 ... 4 mm ²)
• finely stranded with core end processing	2x (0.5 ... 1.5 mm ²), 2x (0.75 ... 2.5 mm ²)
type of connectable conductor cross-sections	
• for auxiliary contacts	
— solid or stranded	2x (0.5 ... 1.5 mm ²), 2x (0.75 ... 2.5 mm ²)
— finely stranded with core end processing	2x (0.5 ... 1.5 mm ²), 2x (0.75 ... 2.5 mm ²)
• for AWG cables for auxiliary contacts	2x (20 ... 16), 2x (18 ... 14)

Safety related data

product function suitable for safety function	Yes
Electrical Safety	
protection class IP on the front according to IEC 60529	IP20
touch protection on the front according to IEC 60529	finger-safe, for vertical contact from the front







Communication/ Protocol



product function bus communication	Yes
protocol is supported AS-Interface protocol	No
product function control circuit interface with IO link	No

Approvals Certificates

General Product Approval	Test Certificates
   	Special Test Certificate Type Test Certificates/Test Report

Maritime application

Maritime application	other	Railway	Environment
		Confirmation	Environmental Confirmations

Further information

Information on the packaging

<https://support.industry.siemens.com/cs/ww/en/view/109813875>

Information for data generation and storage

<https://support.industry.siemens.com/cs/ww/en/view/109995012>

Information- and Downloadcenter (Catalogs, Brochures,...)

<https://www.siemens.com/ic10>

Industry Mall (Online ordering system)

<https://mall.industry.siemens.com/mall/en/en/Catalog/product?mlfb=3RA2318-8XB30-1AB0>

Cax online generator

<https://support.automation.siemens.com/WW/CAXorder/default.aspx?lang=en&mlfb=3RA2318-8XB30-1AB0>

Service&Support (Manuals, Certificates, Characteristics, FAQs,...)

<https://support.industry.siemens.com/cs/ww/en/ps/3RA2318-8XB30-1AB0>

Image database (product images, 2D dimension drawings, 3D models, device circuit diagrams, EPLAN macros, ...)

https://www.automation.siemens.com/bilddb/cax_de.aspx?mlfb=3RA2318-8XB30-1AB0&lang=en

Characteristic: Tripping characteristics, I²t, Let-through current

<https://support.industry.siemens.com/cs/ww/en/ps/3RA2318-8XB30-1AB0/char>

Further characteristics (e.g. electrical endurance, switching frequency)

<https://www.automation.siemens.com/bilddb/index.aspx?view=Search&mlfb=3RA2318-8XB30-1AB0&objecttype=14&gridview=view1>

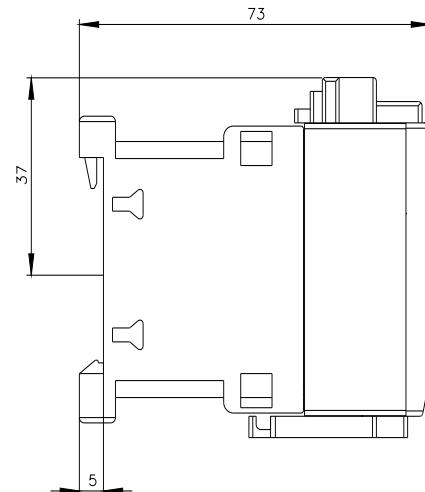
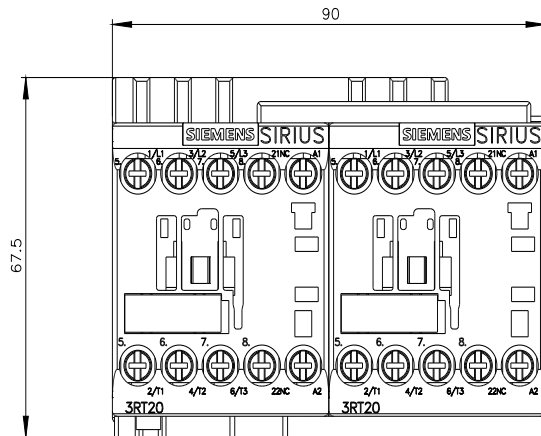

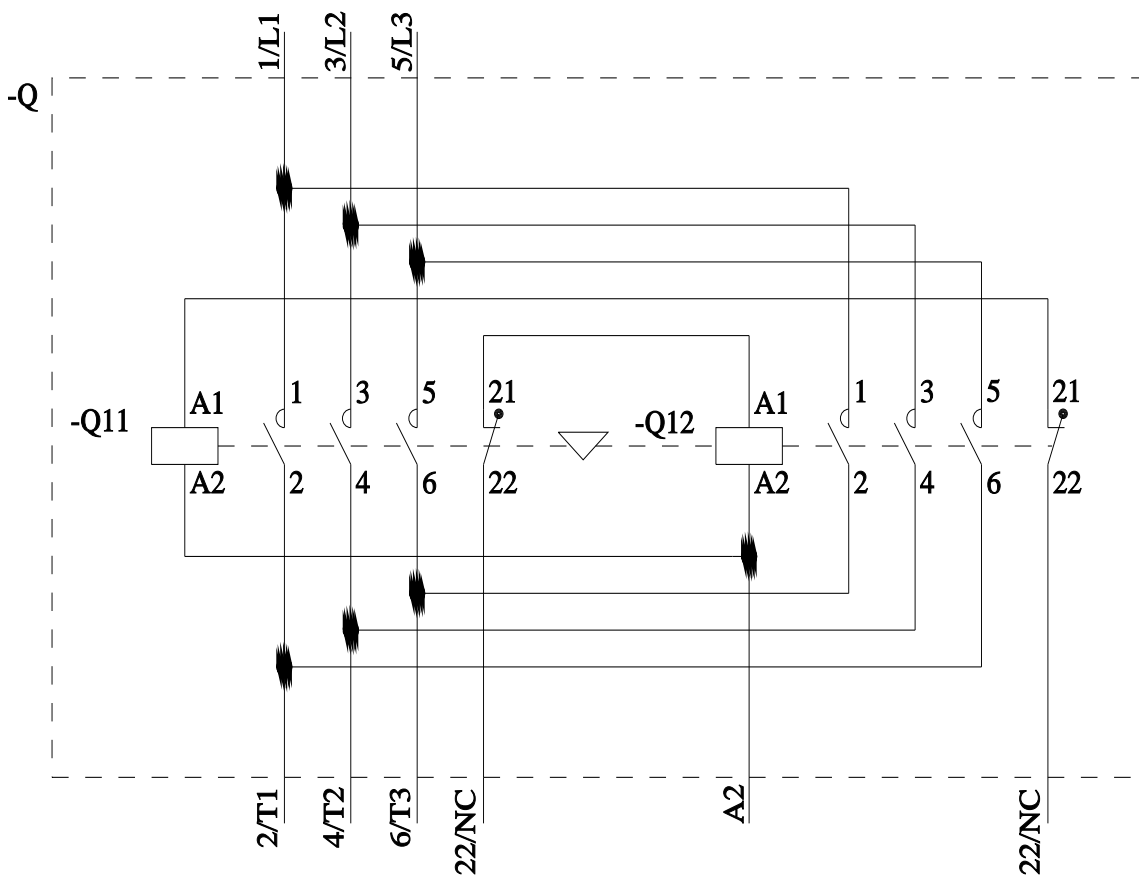

last modified:

5/9/2025 ↗