

Data sheet for SIMOTICS S-1FL2

Article No. : 1FL2102-2AF11-1SC0



Client order no. :
Order no. :
Offer no. :
Remarks :

Item no. :
Consignment no. :
Project :

Basic motor data

Motor type	Permanent-magnet synchronous motor
Motor type	Low Inertia
Static torque	0.16 Nm
Static current	0.84 A
Maximum torque	0.56 Nm
Maximum current	3.40 A
Maximum speed	6,500 rpm
Rotor moment of inertia	0.0170 kgcm ²
Weight	0.45 kg

Rated data

SINAMICS S200, 3 AC 380 ... 480 V

Rated speed	3,000 rpm
Rated torque	0.16 Nm
Rated current	0.84 A
Rated power	0.05 kW

Encoder system

Encoder system Absolute encoder singleturn 21 bit

Motor connection

Connection type Metal hybrid connector

Mechanical data

Design acc. to Code I	IM B5 (IM V1, IM V3)
Vibration severity grade	Grade A
Shaft height	20
Flange size (AB)	40.6 mm
Centering ring (N)	30 mm
Hole circle (M)	46 mm
Screw-on hole (S)	4.4 mm
Overall length (LB)	96.9 mm
Diameter of shaft (D)	8 mm
Length of shaft (E)	25 mm
Length of flange diagonal (P)	54 mm
Shaft end	Shaft with parallel key (half-key balancing)
Color of the housing	Anthracite RAL 7016

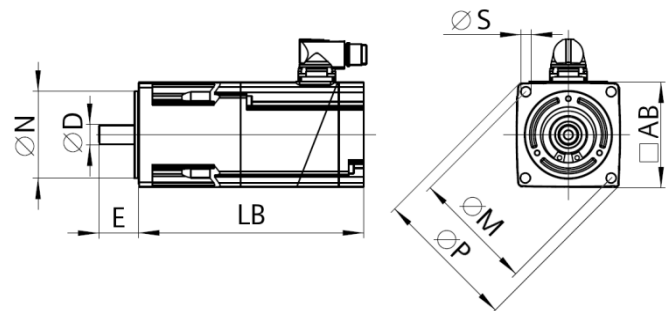

Holding brake

Rated voltage	24 V DC 10 %
Rated current	0.25 A
Holding torque M_{4Br}	0.32 Nm
Opening time	35 ms
Closing time	10 ms