

Article No. : 1FK2104-4AK11-1SB0



Figure similar

Client order no. :
Order no. :
Offer no. :
Remarks :

Item no. :
Consignment no. :
Project :

Basic motor data	
Motor type	Permanent-magnet synchronous motor, Natural cooling, IP65
Motor type	High Dynamic
Static torque	1.27 Nm
Static current	2.4 A
Maximum torque	3.85 Nm
Maximum current	8.7 A
Maximum speed	8,000 rpm
Rotor moment of inertia	0.4300 kgcm ²
Weight	2.9 kg

Rated data	
SINAMICS S120, BLM/SLM 3AC 400V	
Rated speed	6,000 rpm
Rated torque	0.95 Nm
Rated current	1.9 A
Rated power	0.60 kW

Encoder system	
Encoder system	Encoder AS22DQC: Absolute encoder single turn 22 bit

Motor connection	
Connection type	Double cable connection for S120
Connector size power connector	M17
Connector size signal connector	M17

Mechanical data	
Design acc. to Code I	IM B5 (IM V1, IM V3)
Vibration severity grade	Grade A
Shaft height	40
Flange size (AB)	80 mm
Centering ring (N)	70 mm
Hole circle (M)	90 mm
Screw-on hole (S)	6.5 mm
Overall length (LB)	142 mm
Diameter of shaft (D)	19 mm
Length of shaft (E)	40 mm
Length of flange diagonal (P)	105 mm
Shaft end	Fitted key
Color of the housing	Standard (Anthracite, similar to RAL 7016)

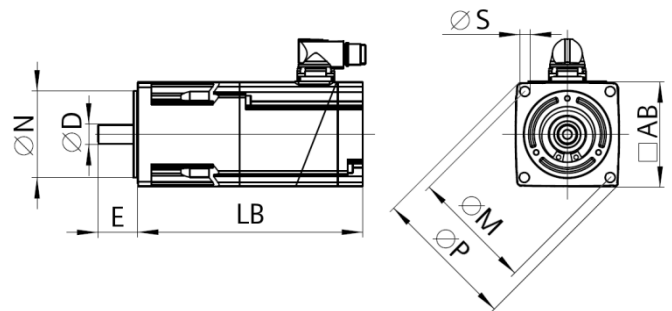

Holding brake	
Holding torque	3.30 Nm
Average dynamic torque	3.30 Nm
Opening time	110 ms
Closing time	40 ms
Maximum single switching energy ¹⁾	270 J
Service life, operating energy	35,000 J
Rated current ²⁾	0.5 A

¹⁾Up to three consecutive emergency stops and up to 25% of all emergency stops as a Wmax high energy stop possible.

²⁾Typical value for 20°C ambient temperature. At -15°C the break-induced currents can be increased by up to 30%.